

SOPHOS

Sophos Firewall

Much More Than a Firewall

Sophos Firewall and XGS Series appliances are at the heart of the world's best network security platform. Consolidate your network protection with our integrated and extensible platform to secure your hybrid networked world.



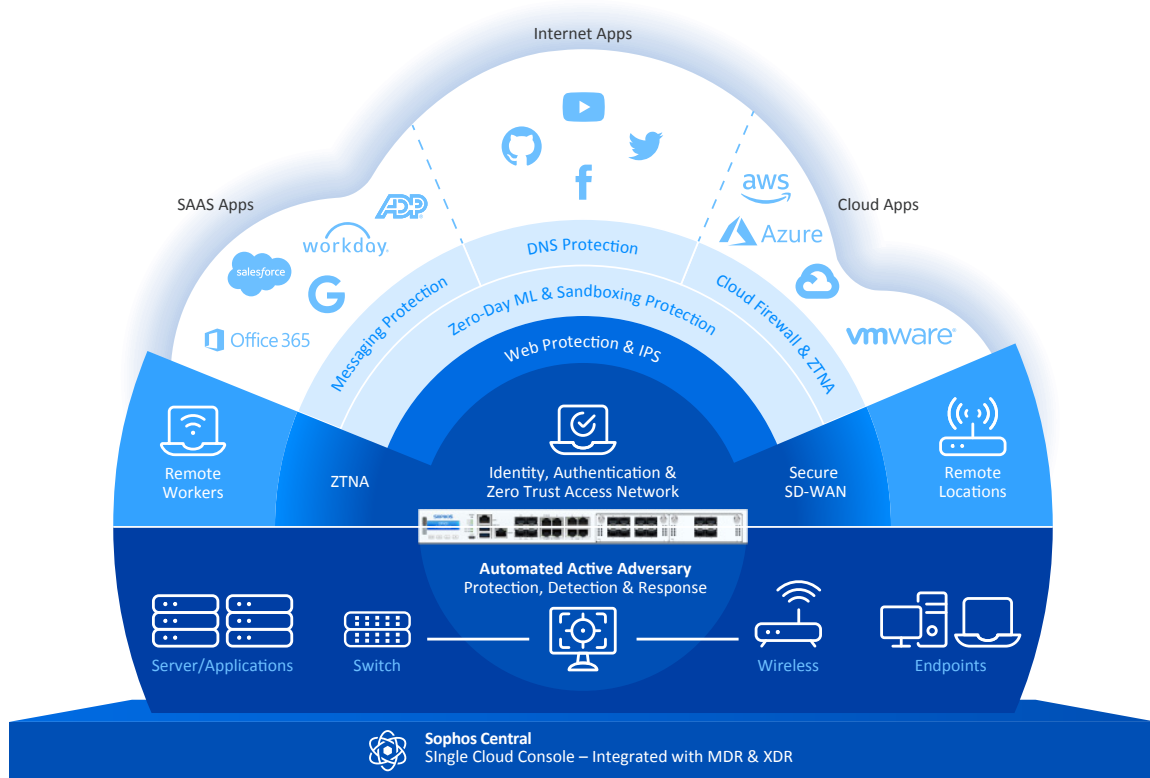

Powerful Protection and Performance

Sophos Firewall includes the latest advanced protection technologies and threat intelligence, including:

- ▶ Streaming DPI engine with web protection and IPS
- ▶ Accelerated TLS 1.3 encrypted traffic inspection
- ▶ Zero-day AI and machine learning analysis
- ▶ Real-time cloud sandboxing
- ▶ DNS Protection

The best part is, you don't need to compromise on performance. This is thanks to our programmable Xstream architecture. It offloads benign traffic flows and crypto operations as well as VPN and select application routing to accelerate these network traffic flows and create performance headroom for traffic that actually needs deep packet inspection.

Sophos Firewall leverages the Sophos Cloud to ensure that your organization is protected from the latest threats and further maximize your performance. You get the latest AI and machine learning technology from SophosLabs working to identify previously unseen threats and malicious URLs. Using a common cloud, any new threat attacking a single Sophos customer is instantly shared across all our customers, blocking it everywhere. In addition, offloading this analysis from your firewall to the cloud boosts your performance even further.

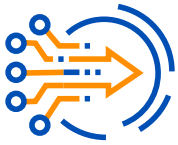

Active Threat Response

Sophos Firewall uniquely integrates with many Sophos products to automatically coordinate a response to an active adversary or attack:

- Sophos Endpoint and XDR
- Sophos Managed Detection and Response services
- Sophos switches and wireless access points
- Sophos ZTNA remote access
- Sophos messaging protection
- And third-party threat intelligence solutions

Regardless of how the threat is first identified, whether at the firewall, by another product, or by a security analyst, Sophos Firewall coordinates a Synchronized Security response across Sophos products. It will identify and isolate the compromised host and prevent lateral movement and external communications until the threat can be investigated and cleaned up.

Sophos Synchronized Security integration between products also provides additional capabilities you can't get anywhere else that adds tremendous value to your network:

- Synchronized Application Control takes advantage of telemetry gathered by the endpoint about active, networked applications and shares that with the firewall enabling control of applications that might otherwise go unidentified.
- Synchronized User ID works similarly to share user identity between the endpoint agent and the firewall to enforce user-based policies without the need for a separate client or server identity solution.
- Synchronized SD-WAN leverages Synchronized Application Control for traffic matching operations to effectively route custom or otherwise unknown application traffic across your network.



Work From Anywhere

Sophos Firewall offers the ultimate in flexible connectivity and secure access for even the most demanding networks. You get a fully integrated SD-WAN solution, along with a full suite of secure access products for Zero Trust Network Access, SD-RED edge devices, VPN, switching, and wireless — all managed from Sophos Central.

Securing and managing remote workers with ZTNA ensures users only have access to the applications they need, and not the whole network. ZTNA also integrates with Sophos Firewall and Sophos Endpoint to ensure a compromised device can't access the network at all. ZTNA also protects your applications from hacks and attacks by making them invisible to the outside world. The best part is, Sophos Firewall integrates a Sophos ZTNA gateway directly into your firewall to make deployment easy.

Sophos Firewall also includes one of the best integrated SD-WAN solutions available in any firewall. Xstream SD-WAN provides a powerful integrated SD-WAN solution with:

- Performance-based link selection and routing
- Load balancing with configurable weightings across multiple links
- Zero-impact transitions between links in the event of a disruption
- Central cloud-managed orchestration
- Xstream FastPath acceleration of VPN tunnel traffic

Sophos Firewall makes interconnecting your hybrid distributed enterprise easy and makes it extremely robust, ensuring maximum reliability and uptime.

Single Console Management

With Sophos Central, you get a single cloud management platform for all your Sophos products, including rich and powerful tools for group firewall management, SD-WAN overlay network orchestration, ZTNA and user management, and infrastructure management for your switches and wireless access points. You also get full in-depth dashboards and reports, cross-product integration and automation with other Sophos products, and much more. Sophos Firewall is so much more than just a firewall – consolidate and streamline your network security management starting with your firewall.

- Manage all of your Sophos Firewalls and other Sophos products from a single console
- Configure changes and apply them to a group of firewalls or manage each firewall individually
- Create a backup schedule and store up to five backups in the cloud
- Schedule firmware updates across your entire network with just a few clicks
- Use zero-touch deployment for new firewalls from Sophos Central: just drop ship the device to any location and set it up remotely. A USB drive is no longer required (but can still be used if you prefer).

Central Management is available at no extra cost.

Sophos Central also includes powerful reporting and orchestration tools that enable you to visualize your network, web, application activity, and security over time:

- Flexible reporting combines a variety of built-in reports with powerful tools that you can use to create your own custom reports
- Analyze data to identify security gaps, suspicious user behavior, or other events requiring policy changes
- Data is shared across Sophos products through the Sophos Central data lake for threat hunting, forensics, and automated response to active threats
- Utilize point-and-click SD-WAN orchestration to easily setup a fully redundant VPN overlay network for your hybrid distributed network
- Central reporting is available at no extra cost with storage of up to seven days of reporting data*

Central Orchestration and Central Reporting with up to 30 days* of data retention are included at no extra charge in the Xstream Protection bundle. Premium reporting options with longer data retention are available for optional purchase.

* Calculated based on average traffic volumes per appliance size. In high-traffic environments, the retention period can be lower.

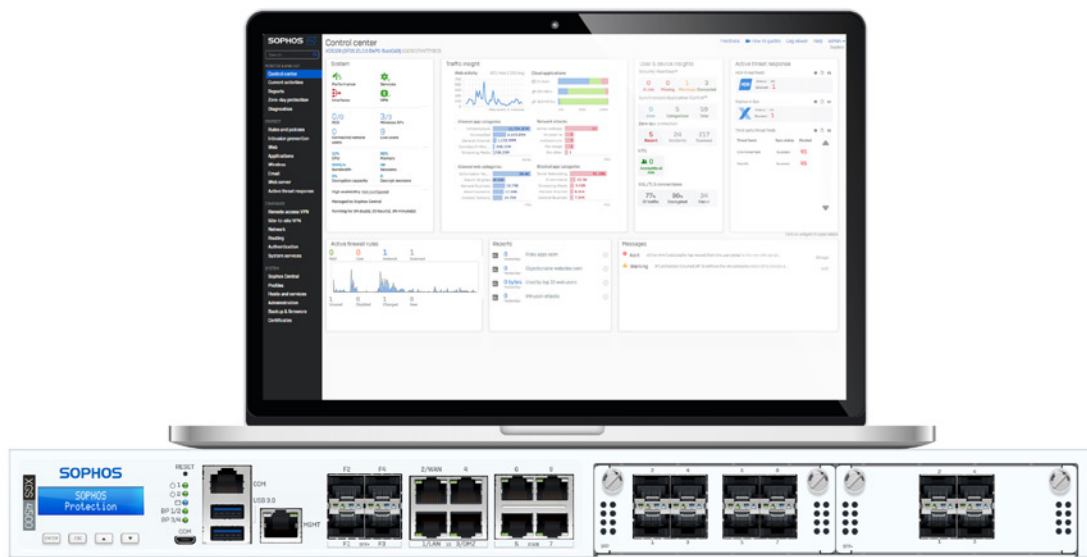

Learn more about the Sophos Central ecosystem at sophos.com/firewall-central

Xstream Protection: A single bundle for ultimate protection

All the next-gen protection, performance, and value you need to power even the most demanding networks. Also available with the XGS Series model of your choice included.



Base Firewall Features

- ▶ **Networking and SD-WAN:** Wireless, SD-WAN, application-aware routing, traffic shaping
- ▶ **Protection and Performance:** Xstream architecture with Network Flow FastPath, TLS 1.3 inspection, deep packet inspection
- ▶ **SD-WAN and VPN:** Xstream SD-WAN, IPsec/SSL site-to-site and remote access VPN (unlimited), SD-RED site-to-site
- ▶ **Reporting:** Historical on-box logging and reporting, Sophos Central cloud reporting (seven-day data retention)



Network Protection

- ▶ **Xstream TLS inspection:** TLS 1.3
- ▶ **Xstream DPI engine:** Streaming deep packet inspection
- ▶ **IPS:** Next-gen intrusion prevention
- ▶ **Active Threat Response:** Sophos X-Ops threat feeds
- ▶ **Synchronized Security:** Automatically identify and isolate threats
- ▶ **Clientless VPN:** HTML5
- ▶ **SD-RED VPN:** Manage SD-RED devices
- ▶ **Reporting:** Extensive network and threat reporting



Web Protection

- ▶ **Xstream TLS inspection:** TLS 1.3
- ▶ **Xstream DPI engine:** Streaming deep packet inspection
- ▶ **Web Control:** By user, group, category, URL, keyword
- ▶ **Web Protection:** from the latest threats
- ▶ **App Control:** By user, group, category, risk, and more
- ▶ **Synchronized App Control:** Identify unknown apps
- ▶ **Synchronized SD-WAN:** Route unknown apps
- ▶ **Reporting:** Extensive web and app reporting



Zero-Day Protection

- ▶ **Xstream TLS inspection:** TLS 1.3
- ▶ **Xstream DPI engine:** Streaming deep packet inspection
- ▶ **Zero-day threat protection:** ML and Sandboxing analysis of files
- ▶ **Machine learning:** Using multiple deep learning models
- ▶ **Cloud sandboxing:** Dynamic run-time analysis of unknown files
- ▶ **Reporting:** Extensive threat intelligence analysis reporting



DNS Protection and Xstream Protection Bundle-Only Features

- ▶ **Domain name resolution service:** Backed by SophosLabs and powered by AI to block malicious or unwanted URLs
- ▶ **Active Threat Response:** For Sophos MDR/XDR threat feeds
- ▶ **Active Threat Response:** For third-party regional/vertical threat feeds



Sophos Central Management

- ▶ **Group firewall management:** Synchronized policy across firewall groups
- ▶ **Backup and firmware updates:** Storage and scheduling
- ▶ **Zero-touch deployment:** For new firewalls from the cloud



Sophos Central Orchestration

- ▶ **SD-WAN orchestration:** Point-and-click site-to-site VPN orchestration
- ▶ **Cloud firewall reporting:** Multi-firewall reporting, save, schedule and export reports (30-day data retention)
- ▶ **XDR and MDR connector:** Support for XDR and MDR services

Enhanced Support

All Licensing Options

We recommend the Xstream Protection bundle for the ultimate in security. If you prefer to customize your protection, all subscriptions are also available for individual purchase.

Xstream Protection Bundle:	
Base License	Networking, wireless, Xstream architecture, unlimited remote access VPN, site-to-site VPN, reporting
Network Protection	Xstream TLS/DPI, IPS, Active Threat Response with Sophos X-Ops threat feeds, Heartbeat, SD-RED, reporting
Web Protection	Xstream TLS and DPI engine, web security and control, application control, reporting
Zero-Day Protection	Machine learning and sandboxing file analysis, reporting
Central Orchestration	SD-WAN VPN orchestration, Central Firewall Advanced Reporting (30-days), MDR/XDR data lake connector
DNS Protection (not sold separately)	Cloud-based DNS service for web security and compliance
Bundle-only Features (not sold separately)	Active Threat Response with MDR/XDR threat feeds and third-party threat feeds
Enhanced Support	24/7 support, feature updates, advanced replacement hardware warranty for term

Custom protection: You can choose the Standard Protection bundle or purchase any of the protection modules separately.

Standard Protection Bundle:	
Base License	Networking, wireless, Xstream architecture, Xstream SD-WAN, unlimited remote access VPN, site-to-site VPN
Network Protection	Xstream TLS and DPI engine, IPS, ATP, Security Heartbeat, manage SD-RED, reporting
Web Protection	Xstream TLS and DPI engine, web security and control, application control, reporting
Enhanced Support	24/7 support, feature updates, advanced replacement hardware warranty for term

Additional Protection Modules:	
Email Protection	On-box anti-spam, AV, DLP, encryption
Web Server Protection	Web Application Firewall

Sophos Central managing and reporting:

Sophos Central Management and Reporting (included at no charge):	
Sophos Central Management	Group firewall management, backup management, firmware update scheduling
Sophos Central Firewall Reporting	Pre-packaged and custom report tools, with seven days cloud storage for no extra charge (see other options)

Additional protection:

Additional Protection Services, Products, and Modules:	
Managed Detection and Response	24/7 threat hunting, detection, and response delivered by an expert team (more info)
Sophos Intercept X Endpoint with XDR	Sophos Central managed next-gen endpoint protection with EDR (more info)
Zero Trust Network Access	A ZTNA gateway is integrated into your firewall (more info)
Central Email Advanced	Sophos Central managed antispam, AV, DLP, encryption (more info)
Sophos Switch	Cloud-managed access layer switches (more info)
Sophos Wireless	Scalable, cloud-managed Wi-Fi (more info)

Support: A support subscription is required to receive firmware upgrades. Enhanced support is included in all protection bundles, but you can upgrade to enhance your support experience further.

Additional Support Options:	
Enhanced Plus Support Upgrade	Upgrade your support with VIP support, hardware warranty for add-ons, TAM option (extra cost) In Active/Passive HA scenarios, Enhanced Plus support is required in the primary device to be eligible for Advanced RMA on the passive device

Cloud, virtual, and software application licensing options:

If you're deploying Sophos Firewall in the cloud, in a virtual environment, or as software on your own hardware, the licensing guide below can help you find the right option.

Model	Equivalent AWS instance	Equivalent Azure VM	Software/Virtual License*
XGS 88(w)/87(w)	t3.medium	-	2C4
XGS 108(w)/107(w)	c5.large	Standard_F2s_v2	-
XGS 118(w)/116(w)	-	-	4C6
XGS 2100	c5.xlarge	-	-
XGS 2300	m5.xlarge	Standard_F4s_v2	6C8
XGS 3100	c5.2xlarge	Standard_F8s_v2	8C16
XGS 4300	c5.4xlarge	Standard_F16s_v2	16C24
XGS 5500	c5.9xlarge	Standard_F32s_v2	Unlimited

* Based upon CPU cores and RAM

For a complete list of features included in each protection subscription, see the [Sophos Firewall Feature List](#).

Deployment Options

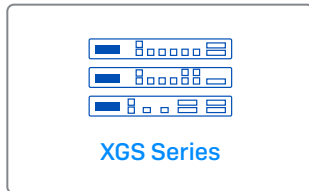

Purpose-built devices to provide the ultimate in performance.

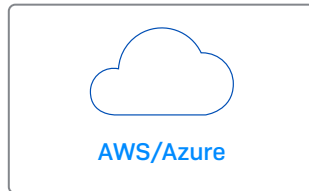

Protect your network infrastructure in the AWS or Azure cloud.

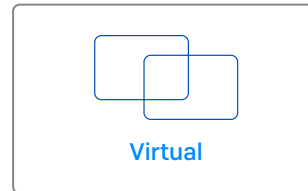

Install on VMware, Citrix, Microsoft Hyper-V, and KVM.

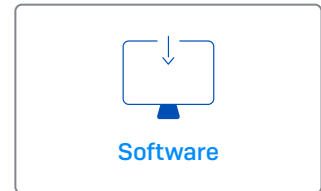

Install the Sophos Firewall OS image on your own Intel hardware or server.

Cloud

Sophos Firewall offers the best network visibility, protection, and response capabilities to secure your public, private, and hybrid cloud environments.



As an AWS Advanced Technology Partner, Sophos is a validated AWS Security Competency vendor, AWS Marketplace seller, and AWS Public Sector Partner (PSP).

Sophos Firewall is now available in the AWS Marketplace, with auto-scaling support with either a pay-as-you-go (PAYG) license model or bring your own license (BYOL) to best fit your needs.



Sophos Firewall is certified and optimized for Azure and is available in the Microsoft Azure Marketplace. Take advantage of the free test drive or the flexible PAYG or BYOL licensing options.



Sophos Firewall is Nutanix AHV and Nutanix Flow Ready, bringing the world's best next-gen firewall visibility, protection, and response to the industry's leading hyper-converged infrastructure (HCI) platform. Take advantage of a 30-day free trial using our KVM image and flexible licensing.

Virtual and software

Sophos Firewall supports a broad range of virtualization platforms and can also be deployed as a software appliance on your own x86 Intel hardware.



See the [Licensing section](#) for available licensing options.

Protection Modules

You can choose from a number of modules to customize the protection offered by your firewall to your individual needs and deployment scenario.

Base Sophos Firewall

The Sophos Firewall Base License includes the Xstream architecture, networking, wireless, SD-WAN, VPN, and reporting.

Xstream architecture

Enables high-performance TLS 1.3 inspection, deep packet inspection, and network flow FastPath to accelerate trusted SaaS, SD-WAN, and cloud application traffic. Note that Network and Web Protection are required to get the full benefits of the Xstream architecture.

Xstream SD-WAN and networking

Includes all networking, routing, and SD-WAN capabilities, including zone-based stateful firewall, NAT, VLAN, SD-WAN profiles, performance-based WAN link selection and monitoring, load balancing, zero-impact WAN link transitions, and Xstream FastPath acceleration of trusted application traffic, IPsec VPN traffic, and TLS encrypted traffic flows.

Secure Wireless

Built-in wireless controller for Sophos APX Wi-Fi 5 access points (no longer sold). Plug-and-play access point discovery makes setup easy. Support for multiple SSIDs, hotspots, guest networks, and diverse encryption and security standards.

Wi-Fi 6/6E support is available using our separate, cloud-managed Wi-Fi solution.

VPN

Provides standards-based site-to-site and remote access VPN (free up to the capacity of the firewall), with support for IPsec and SSL. Sophos Connect remote access VPN client for Windows and Macs offers seamless and easy deployment and configuration options. SD-RED layer 2 site-to-site tunnels offer a lightweight robust VPN alternative.

Reporting

Extensive on-box reporting provides valuable insights into threats, users, applications, web activity, and much more. Note that specific reporting functionality may be dependent on other protection modules to get the full benefits (for example, web protection or web and app reports).

The Base Firewall is included with every appliance.

Network Protection

All the protection you need to stop sophisticated attacks and advanced threats while providing secure network access to those you trust.

Next-Gen intrusion prevention system

Provides advanced protection from all types of modern attacks. It goes beyond traditional server and network resources to protect users and apps on the network as well.

Security Heartbeat

Creates a link between your Sophos Central protected endpoints and your firewall to identify threats faster, simplify investigation, and minimize the impact of attacks. Easily incorporate the Security Heartbeat status into firewall policies to automatically isolate compromised systems.

Advanced Threat Protection

Instant identification and immediate response to today's most sophisticated attacks. Multi-layered protection identifies threats instantly, and Security Heartbeat provides an emergency response.

Advanced VPN technologies

Adds unique and simple VPN technologies, including our clientless HTML5 self-service portal that makes remote access incredibly simple, plus management for our exclusive lightweight and secure SD-RED VPN technology.

Network Protection is included in the Xstream and Standard Protection bundles and is also available for separate purchase.

Web Protection

Unmatched visibility and control over all of your users web and application activity.

Powerful user and group web policy

Provides enterprise-level Secure Web Gateway policy controls to easily manage sophisticated user and group web controls. Apply policies based on uploaded web keywords indicating inappropriate use or behavior.

Application control and QoS

Enables user-aware visibility and control over thousands of applications with granular policy and traffic-shaping (QoS) options based on application category, risk, and other characteristics. Synchronized Application Control automatically identifies all unknown, evasive, and custom applications on your network.

Advanced web threat protection

Backed by SophosLabs, our advanced engine provides the ultimate protection from today's polymorphic and obfuscated web threats. Innovative techniques like JavaScript emulation, behavioral analysis, and origin reputation help keep your network safe.

High-performance traffic scanning

Optimized for top performance, our Xstream SSL inspection provides ultra-low latency inspection and HTTPS scanning while maintaining performance.

Web Protection is included in the Xstream and Standard Protection bundles and is also available for separate purchase.

DNS Protection

Cloud-based DNS service for added web security and compliance.

High-performance domain-level protection

Sophos DNS Protection is a cloud-based service providing DNS resolution and an added layer of web security to your networks. It works instantly to block access to unsafe and unwanted domains across all ports, protocols, and applications from both managed and unmanaged devices.

Integrated Compliance Controls

Easily add an additional layer of compliance controls to your network to block access to common unwanted site categories across your entire network.

Powered by AI

Sophos DNS Protection is continually updated by SophosLabs using the latest in AI analysis to identify malicious and unwanted sites which are shared across all customers in real-time as soon as they are discovered.

DNS Protection is included in the Xstream Protection bundle and is not available for separate purchase.

Zero-Day Protection

AI-driven static and dynamic file analysis techniques combine to bring unprecedented threat intelligence to your firewall and effectively identify and block ransomware and other known and unknown threats.

Powered by SophosLabs

Powered by the industry-leading SophosLabs, the Zero-Day Protection subscription includes a fully cloud-based threat intelligence and threat analysis platform. This provides deep learning-based file analysis, detailed analysis reporting, and a threat meter to show the risk summary for a file.

We use layers of analytics to identify known and potential threats, reduce unknowns, and derive verdicts and intelligence reports for the most commonly used file types.

Static file analysis

By harnessing the power of multiple machine learning models, global reputation, deep file scanning, and more, you can quickly identify threats without the need to execute files in real time.

Dynamic file analysis

Execute a file in a secure cloud-based sandbox to observe its behavior and intent. Screenshots provide added insights into any key events during the analysis.

Threat intelligence analysis reporting

Rich intelligence reports provide you with more than just a "good," "bad," or "unknown" verdict. Full insight into the nature and capabilities of a threat is delivered through the use of data science and SophosLabs research.

Zero-Day Protection is included in the Xstream Protection bundle and is also available for separate purchase.

Central Orchestration

Sophos Central cloud-managed VPN orchestration, firewall reporting, and MDR/XDR integration.

Sophos Central SD-WAN orchestration

Makes VPN orchestration easy. Wizard-based tunnel configuration helps create full mesh networks, hub-and-spoke models, or complex tunnel setups between multiple firewalls a quick point-and-click exercise. Seamlessly integrates multiple WAN link and SD-WAN functionality and routing optimizations to improve resilience performance. Also integrates with user authentication and Security Heartbeat to control access.

Central Firewall Reporting Advanced (30 Days)

Cloud-based reporting with several pre-packaged common reports for threats, compliance, and user activity. Includes advanced options for creating custom reports and views with the option to save, schedule, or export your custom reports. Includes 30 days of log data retention with the option to add additional storage for more comprehensive historical reporting requirements.

MDR/XDR connector

Sophos MDR provides optional 24/7 threat hunting, detection, and response delivered by an expert team as a fully managed service. Sophos XDR offers extended detection and response managed by your team.

Regardless of whether you manage it yourself or Sophos manages it for you, your Sophos Firewall is ready to share the necessary threat intelligence and data to the cloud.

Central Orchestration is included in the Xstream Protection bundle and is available for separate purchase.

Zero Trust Network Access

Provide secure remote access to applications and systems behind your firewall.

Integrated ZTNA gateway

Sophos Firewall provides an integrated Sophos ZTNA gateway at no extra cost. This simplifies ZTNA deployments by eliminating the need for a separate VM gateway, making deployments faster and easier. Sophos ZTNA is the ultimate remote access VPN replacement, providing better security, easier management, and a transparent user experience.

ZTNA gateways are available at no extra cost. User-based client licenses for ZTNA are sold separately.

Email Protection

Consolidate your email protection with anti-spam, DLP, and encryption. We recommend Sophos Central Email Advanced for the best cloud-based email protection solution. If you require on-box email protection, this module offers essential anti-spam, DLP, and encryption.

Integrated message transfer agent

Ensures always-on business continuity for your email, allowing the firewall to automatically queue mail in the event that servers become unavailable.

Live anti-spam

Provides protection from the latest spam campaigns, phishing attacks, and malicious attachments.

Self-serve quarantine

Gives employees direct control over their spam quarantine, saving you time and effort.

SPX email encryption

Unique to Sophos, SPX makes it easy to send encrypted emails to anyone, even those without any kind of trust infrastructure, using our patent-pending password-based encryption technology.

Data loss prevention

Policy-based DLP can automatically trigger encryption or block/notify based on the presence of sensitive data in emails leaving the organization.

Email Protection is available for individual purchase only.

Web Server Protection

Harden your web servers and business applications against hacking attempts and provide secure access.

Business application policy templates

Pre-defined policy templates let you protect common applications like Microsoft Exchange Outlook Anywhere or SharePoint quickly and easily.

Protection from the latest hacks and attacks

Offers a variety of advanced protection technologies, including URL and form hardening, deep-linking and directory traversal prevention, SQL injection and cross-site scripting protection, cookie signing, and more.

Reverse Proxy

Authentication options, SSL offloading, and server load balancing ensure maximum protection and performance for your servers being accessed from the internet.

Web Server Protection is available for individual purchase only.

Sophos XGS Series Appliances

The XGS Series models offer excellent performance and connectivity at every price point to power the protection you need for today's diverse, distributed, and encrypted networks.

Product Matrix

Model		Tech Specs			Throughput			
	Form Factor	Ports/Slots (Max Ports)	w-model	Swappable Components	Firewall (Mbps)	IPsec VPN (Mbps)	Threat Protection (Mbps)	Xstream SSL/TLS (Mbps)
XGS 88(w)	Gen.2 Desktop ²	4/- (4)	Wi-Fi 6	n/a	9,900	6,000	2,000	600
XGS 108(w)		7/- (7)		Optional: 2 nd power supply, 5G module ³	12,500	8,250	2,500	800
XGS 118(w)		10/1 (10)			15,500	13,000	3,250	1,100
XGS 128(w)		10/1 (10)			19,100	15,050	4,000	1,450
XGS 138 ¹		8/1 (8)	n/a	19,100	6,600	4,750	1,700	
XGS 87(w)	Gen.1 Desktop	5/- (5)	Wi-Fi 5	n/a	3,850	3,000	850	375
XGS 107(w)		9/- (9)		Optional: 2 nd power supply	7,000	4,000	1,110	420
XGS 116(w)		9/1 (9)	Optional: 2 nd power supply, 3G/4G module, 5G module, Wi-Fi module ⁴	7,700	4,800	2,160	650	
XGS 126(w)		14/1 (14)		10,500	5,500	2,700	800	
XGS 136(w)				11,500	6,350	3,000	950	
XGS 2100	1U Short	10/1 (18)	n/a	Optional: external power supply	30,000	17,000	5,000	1,100
XGS 2300			n/a		39,000	20,500	5,550	1,450
XGS 3100		12/1 (20)	n/a		47,000	25,500	7,400	2,470
XGS 3300			n/a		58,000	31,100	10,000	3,130
XGS 4300	1U Long	12/2 (28)	n/a	Optional: internal power supply	75,000	62,500	25,200	8,000
XGS 4500			n/a		80,000	75,550	31,850	10,600
XGS 5500	2U	16/3 (48)	n/a	Built in: redundant power, SSDs, fans	100,000	92,500	46,000	13,500
XGS 6500		20/4 (68)	n/a		120,000	109,800	53,500	16,000
XGS 7500			n/a		160,000	117,000	70,000	19,500
XGS 8500		22/4 (70)	n/a		190,000	141,000	92,500	24,000

1 Currently not available in Japan

2 All Gen.2 Desktop models include two or more 2.5 GE ports

3 Not sold in Japan

4 2nd Wi-Fi module option for XGS 116w, 126w and 136w only

Performance test methodology

General: Maximum throughput measured under ideal test conditions using industry-standard Keysight-Ixia BreakingPoint test tools. Actual performance may vary depending on network conditions and activated services

- **Firewall:** Measured using HTTP traffic and 512 KB response size.
- **Firewall IMIX:** UDP throughput based on a combination of 66 byte, 570 byte, and 1518 byte packet sizes.
- **IPS:** Measured with IPS with HTTP traffic using default IPS ruleset and 512 KB object size.
- **IPsec VPN:** HTTP throughput using multiple tunnels and 512 KB HTTP response size.
- **TLS Inspection:** Performance measured with IPS with HTTPS sessions and different cipher suites.
- **Threat Protection:** Measured with firewall, IPS, application control, and malware prevention enabled using Enterprise Traffic Mix.
- **NGFW:** Measured with IPS and application control enabled with HTTP traffic using default IPS ruleset and 512KB object size.

Need sizing help?

Sophos offers free sizing assistance and a firewall sizing tool for partners via the Partner Portal.

Sophos XGS Series Desktop: SMB and Branch Office

Our two generations of desktop appliances offer great value, performance, and efficiency for small businesses, retail outlets, and branch offices.

2nd Generation XGS Desktop

The 2nd generation XGS desktop models unlock a wealth of new features and high-speed connectivity options.

Product highlights

- ▶ **Accelerated performance:** up to double the throughput of Gen.1 models plus Xstream virtual FastPath acceleration for IPsec VPN (XGS 88 to XGS 128) in combination with SFOS v21 and higher
- ▶ **High-speed connectivity built in:** 2.5 GE interfaces on every model, two built-in 10 GE SFP+ interfaces on the XGS 138, Wi-Fi integrated models support Wi-Fi 6 (802.11ax) with concurrent use of the 2.4 and 5 GHz bands for better performance
- ▶ **Power and environment:** up to 50% lower power consumption, fanless XGS 88 and 108 models for whisper-quiet operation, optimized thermal design for XGS 118 and above, redundant power option for all XGS 1xx models
- ▶ **Optional connectivity:** new 5G module available exclusively for Gen.2 models for more cost-effective redundant connectivity
- ▶ **Streamlined hardware architecture:** the XGS 88 to XGS 128 models boast a new single-CPU architecture while the XGS 138 has a refreshed dual-processor architecture

Available models

XGS 88 and XGS 88w

See detailed [technical specifications](#)

XGS 108, XGS 108w

See detailed [technical specifications](#)

XGS 118, XGS 118w

See detailed [technical specifications](#)

XGS 128, XGS 128w

See detailed [technical specifications](#)

XGS 138

See detailed [technical specifications](#)

1st Generation XGS Desktop

The original XGS desktop models combine advanced hardware technology with excellent value and connectivity.

Product highlights

- ▶ **Hardware acceleration:** Xstream Flow Processor for hardware-level acceleration of trusted and previously verified apps and traffic
 - ▶ **Extensive built-in connectivity:** SFP interface on every model, all models available with optional integrated Wi-Fi 5 (802.11ac), built-in Power-over-Ethernet on all XGS 116, 126, and 136 models (2.5 GE on XGS 136)
 - ▶ **Power and environment:** Redundant power option for all XGS 1xx models, optimized energy consumption
- For highly noise-sensitive environments, we recommend the fanless XGS 88 and XGS 108 (Gen.2) models
- ▶ **Add-on connectivity options:** optional 3G/4G and 5G using the expansion bay on all XGS 116/126/136 models, an optional second Wi-Fi radio module can be added to w-models with an expansion bay
 - ▶ **Dual-processor architecture:** all Gen.1 models include an x86 CPU plus an Xstream Flow Processor (NPU)

Available models

XGS 87 and XGS 87w

See detailed [technical specifications](#)

XGS 107, XGS 107w

See detailed [technical specifications](#)

XGS 116, XGS 116w

See detailed [technical specifications](#)

XGS 126, XGS 126w

See detailed [technical specifications](#)

XGS 136, XGS 136w

See detailed [technical specifications](#)



Note: All protection features are supported on every XGS 1xx model and most on XGS 87(w) and XGS 88(w)

Sophos XGS Series Desktop: SMB and Branch Office

Gen.2: XGS 88 and XGS 88w

Technical specifications

Note: The XGS 88 and 88w do not support some advanced features like on-box reporting, dual AV scanning, WAF AV scanning, and the email message transfer agent (MTA) functionality. If you need these capabilities, the XGS 108(w) is recommended.

Front View



Back View

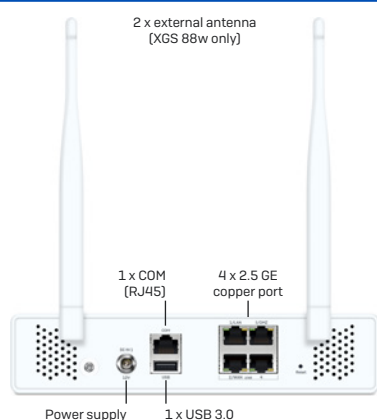

Physical Specifications

Mounting	Rackmount kit available (to be ordered separately)
Dimensions: Width X height X depth	200 x 44 x 180 mm
Weight	1.4 kg/3.08 lbs (unpacked) 2 kg/4.41 lbs (packed) (w-model minimally more)

Environment

Power supply	External auto-ranging AC-DC 100-240VAC, 1.7A@50-60 Hz 12VDC, 3.33A, 40W
Power consumption (typical)	12.5 W/42.65 BTU/hr (88 idle) 14.5 W/49.48 BTU/hr (88w idle) 18 W/61.42 BTU/hr (88 max.) 22 W/75.07 BTU/hr (88w max.)
Noise level (avg.)	0 dBA - fanless
Operating temperature	0°C to 40°C (operating) -20°C to +70°C (storage)
Humidity	10% to 90%, non-condensing

Product Certifications

Certifications	CB, CE, UKCA, UL, FCC, ISED, VCCI, KC*, BSMI, RCM, NOM, Anatel*, TEC
-----------------------	--

* XGS 88 only

Performance	XGS 88(w)
Firewall throughput	9,900 Mbps
Firewall IMIX	6,500 Mbps
IPS throughput	2,000 Mbps
Threat protection throughput	2,000 Mbps
NGFW	2,000 Mbps
Concurrent connections	1,600,000
New connections/sec	40,500
IPsec VPN throughput	6,000 Mbps
IPsec VPN concurrent tunnels	500
SSL VPN concurrent tunnels	500
Xstream SSL/TLS Inspection	600 Mbps
Xstream SSL/TLS concurrent connections	8,192

Note: For performance testing methodology, see [page 10](#)

Wireless Specification (XGS 88w only)

No. of antennas	2 external
MIMO capabilities	2 x 2:2
Wireless interface	Wi-Fi 6 (802.11ax) 2.4 GHz/5 GHz concurrent

Physical Interfaces

Storage	16 GB eMMC
Ethernet interfaces (fixed)	4 x 2.5 GE copper
Management ports	1 x COM RJ45 1 x Micro-USB (cable incl.)
Other I/O ports	1 x USB 2.0 (front) 1 x USB 3.0 (rear)
Number of expansion slots	0
Optional add-on connectivity	n/a

Sophos XGS Series Desktop: SMB and Branch Office

Gen.2: XGS 108, XGS 108w

Technical specifications

Front View



Back View

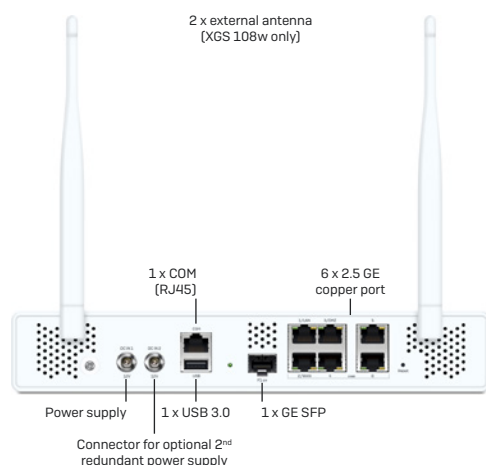

Physical Specifications

Mounting	Rackmount kit available (to be ordered separately)
Dimensions: Width X height X depth	260 x 44 x 180 mm
Weight	1.8 kg/3.97 lbs (unpacked) 2.4 kg/5.29 lbs (packed) (w-model minimally more)

Environment

Power supply	External auto-ranging AC-DC 100-240VAC, 2A@50-60 Hz 12VDC, 5A, 60W Optional second redundant power supply
Power consumption	21.5 W/73.36 BTU/hr (108 idle) 25.5 W/87.01 BTU/hr (108w idle) 27 W/92.13 BTU/hr (108 max.) 30 W/102.36 BTU/hr (108w max.)
Noise level (avg.)	0 dBA - fanless
Operating temperature	0°C to 40°C (operating) -20°C to +70°C (storage)
Humidity	10% to 90%, non-condensing

Product Certifications

Certifications	CB, CE, UKCA, UL, FCC, ISED, VCCI, KC*, BSMI, RCM, NOM, Anatel*, TEC
-----------------------	--

* XGS 108 only

Performance	XGS 108(w)
Firewall throughput	12,500 Mbps
Firewall IMIX	8,100 Mbps
IPS throughput	2,500 Mbps
Threat Protection throughput	2,500 Mbps
NGFW	2,600 Mbps
Concurrent connections	4,190,000
New connections/sec	53,000
IPsec VPN throughput	8,250 Mbps
SSL VPN concurrent tunnels	1,000
IPsec VPN concurrent tunnels	1,000
Xstream SSL/TLS Inspection	800 Mbps
Xstream SSL/TLS concurrent connections	12,288

Note: For performance testing methodology, see [page 10](#)

Wireless Specification (XGS 108w only)

No. of antennas	2 external
MIMO capabilities	2 x 2:2
Wireless interface	Wi-Fi 6 (802.11ax) 2.4 GHz/5 GHz concurrent

Physical Interfaces

Storage (local quarantine/logs)	64 GB UFS 2.1
Ethernet interfaces (fixed)	6 x 2.5 GE copper 1 x SFP fiber
Management ports	1 x COM RJ45 1 x Micro-USB (cable incl.)
Other I/O ports	1 x USB 2.0 (front) 1 x USB 3.0 (rear)
Number of expansion slots	0
Optional add-on connectivity	n/a

Sophos XGS Series Desktop: SMB and Branch Office

Gen.2: XGS 118, XGS 118w

Technical specifications

Front View



Back View

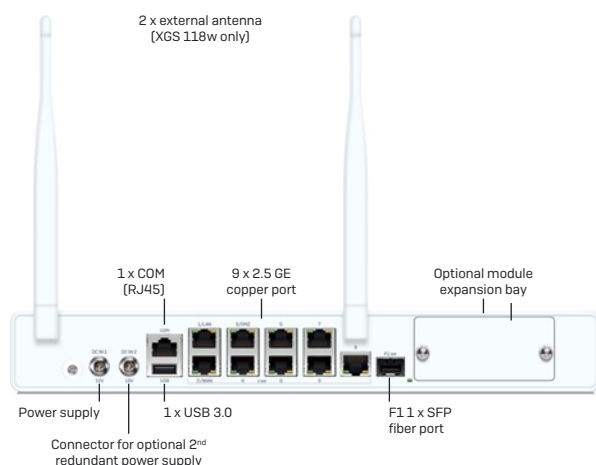

Physical Specifications

Mounting	Rackmount kit available (to be ordered separately)
Dimensions: Width X height X depth	320 x 44 x 212 mm
Weight	2.4 kg/5.29 lbs (unpacked) 3.9 kg/8.60 lbs (packed) (w-model minimally more)

Environment

Power supply	External auto-ranging AC-DC 100-240VAC, 2A@50-60 Hz 12VDC, 5.42A, 65W Optional second redundant power supply
Power consumption	25.5 W/87.01 BTU/hr (118 idle) 29.5 W/100.66 BTU/hr (118w idle) 28 W/95.54 BTU/hr (118 max.) 34 W/116.01 BTU/hr (118w max.)
Noise level (avg.) Typical/Max. operation	XGS 118 - 17.3/26.9 dBA XGS 118(w) - 19.5/31 dBA
Operating temperature	0°C to 40°C (operating) -20°C to +70°C (storage)
Humidity	10% to 90%, non-condensing

Product Certifications

Certifications	CB, CE, UKCA, UL, FCC, ISED, VCCI, KC*, BSMI, RCM, NOM, Anatel*, TEC
-----------------------	--

* XGS 118 only

Performance	XGS 118(w)
Firewall throughput	15,500 Mbps
Firewall IMIX	11,000 Mbps
IPS throughput	3,500 Mbps
Threat Protection throughput	3,250 Mbps
NGFW	3,950 Mbps
Concurrent connections	5,500,000
New connections/sec	62,650
IPsec VPN throughput	13,000 Mbps
IPsec VPN concurrent tunnels	1,500
SSL VPN concurrent tunnels	1,250
Xstream SSL/TLS Inspection	1,100 Mbps
Xstream SSL/TLS concurrent connections	18,432

Note: For performance testing methodology, see [page 10](#)

Wireless Specification (XGS 118w only)

No. of antennas	2 external
MIMO capabilities	2 x 2:2
Wireless interface	Wi-Fi 6 (802.11ax) 2.4 GHz/5 GHz concurrent

Physical Interfaces

Storage (local quarantine/logs)	64 GB UFS 2.1
Ethernet interfaces (fixed)	9 x 2.5 GE copper 1 x SFP fiber
Power-over-Ethernet (fixed)	0
Management ports	1 x COM RJ45 1 x Micro-USB (cable incl.)
Other I/O ports	1 x USB 2.0 (front) 1 x USB 3.0 (rear)
Number of expansion slots	1
Optional add-on connectivity	5G module (Gen.2)

* SFP transceivers sold separately

Sophos XGS Series Desktop: SMB and Branch Office

Gen.2: XGS 128, XGS 128w

Technical specifications

Front View



Back View

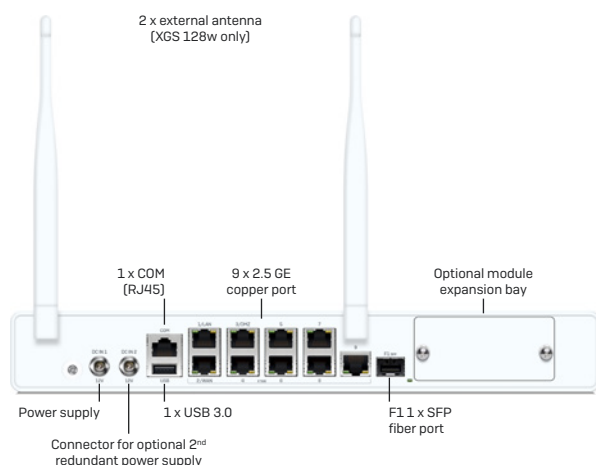

Physical Specifications

Mounting	Rackmount kit available (to be ordered separately)
Dimensions: Width X height X depth	320 x 44 x 212 mm
Weight	2.4 kg/5.29 lbs (unpacked) 3.9 kg/8.60 lbs (packed) (w-model minimally more)

Environment

Power supply	External auto-ranging AC-DC 100-240VAC, 2A@50-60 Hz 12VDC, 5.42A, 65W Optional second redundant power supply
Power consumption	26.5 W/90.42 BTU/hr [128 idle] 30 W/102.36 BTU/hr [128w idle] 30 W/102.36 BTU/hr [128 max.] 35 W/119.42 BTU/hr [128w max.]
Noise level (avg.) Typical/Max. operation	XGS 128 - 17.3/26.9 dBA XGS 128(w) - 19.5/31 dBA
Operating temperature	0°C to 40°C (operating) -20°C to +70°C (storage)
Humidity	10% to 90%, non-condensing

Product Certifications

Certifications	CB, CE, UKCA, UL, FCC, ISED, VCCI, KC*, BSMI, RCM, NOM, Anatel*, TEC
-----------------------	--

* XGS 128 only

Performance	XGS 128(w)
Firewall throughput	19,100 Mbps
Firewall IMIX	14,500 Mbps
IPS throughput	4,650 Mbps
Threat Protection throughput	4,000 Mbps
NGFW	4,350 Mbps
Concurrent connections	6,000,000
New connections/sec	72,250
IPsec VPN throughput	15,050 Mbps
IPsec VPN concurrent tunnels	2,500
SSL VPN concurrent tunnels	1,500
Xstream SSL/TLS Inspection	1,450 Mbps
Xstream SSL/TLS concurrent connections	18,432

Note: For performance testing methodology, see [page 10](#)

Wireless Specification (XGS 128w only)

No. of antennas	2 external
MIMO capabilities	2 x 2:2
Wireless interface	Wi-Fi 6 (802.11ax) 2.4 GHz/5 GHz concurrent

Physical Interfaces

Storage (local quarantine/logs)	64 GB UFS 2.1
Ethernet interfaces (fixed)	9 x 2.5 GE copper 1 x SFP fiber
Power-over-Ethernet (fixed)	0
Management ports	1 x COM RJ45 1 x Micro-USB (cable incl.)
Other I/O ports	1 x USB 2.0 (front) 1 x USB 3.0 (rear)
Number of expansion slots	1
Optional add-on connectivity	5G module (Gen.2)

Sophos XGS Series Desktop: SMB and Branch Office

Gen.2: XGS 138

Technical specifications

Front View



Back View

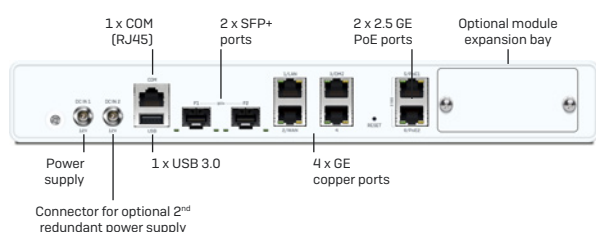

Physical Specifications

Mounting	Rackmount kit available (to be ordered separately)
Dimensions: Width X height X depth	320 x 44 x 212 mm
Weight	2.4 kg/5.29 lbs (unpacked) 4.4 kg/9.70 lbs (packed)

Environment

Power supply	External auto-ranging AC-DC 100-240VAC, 2A@50-60 Hz 12VDC, 12.5A, 150W Optional second redundant power supply
Power consumption	33 W/112.60 BTU/hr (idle) 51 W/174.02 BTU/hr (max.)
PoE addition enabled	121 W/412.87 BTU/hr (max.)
Noise level (avg.) Typical/Max. operation	28/43 dBA
Operating temperature	0°C to 40°C (operating) -20°C to +70°C (storage)
Humidity	10% to 90%, non-condensing

Product Certifications

Certifications	CB, CE, UKCA, UL, FCC, ISED, VCCI, KC, BSMI, RCM, NOM, Anatel, TEC
-----------------------	--

Performance	XGS 138
Firewall throughput	19,100 Mbps
Firewall IMIX	10,500 Mbps
IPS throughput	5,850 Mbps
Threat Protection throughput	4,750 Mbps
NGFW	5,100 Mbps
Concurrent connections	6,550,000
New connections/sec	105,000
IPsec VPN throughput	6,600 Mbps
IPsec VPN concurrent tunnels	2,500
SSL VPN concurrent tunnels	1,500
Xstream SSL/TLS Inspection	1,700 Mbps
Xstream SSL/TLS concurrent connections	18,432

Note: For performance testing methodology, see [page 10](#)

Physical Interfaces

Storage [local quarantine/logs]	64 GB M.2
Ethernet interfaces (fixed)	4 x GE copper 2 x 2.5 GE copper 2 x SFP+ fiber
Power-over-Ethernet (fixed)	2 x 2.5 GE (30W max. per port)
Management ports	1 x COM RJ45 1 x Micro-USB (cable incl.)
Other I/O ports	1 x USB 2.0 (front) 1 x USB 3.0 (rear)
Number of expansion slots	1
Optional add-on connectivity	5G module (Gen.2)

Sophos XGS Series Desktop: SMB and Branch Office

Gen.1: XGS 87 and XGS 87w

Technical specifications

Note: The XGS 87 and 87w do not support some advanced features like on-box reporting, dual AV scanning, WAF AV scanning, and the email message transfer agent (MTA) functionality. If you need these capabilities, the XGS 107(w) is recommended.

Front View



Back View

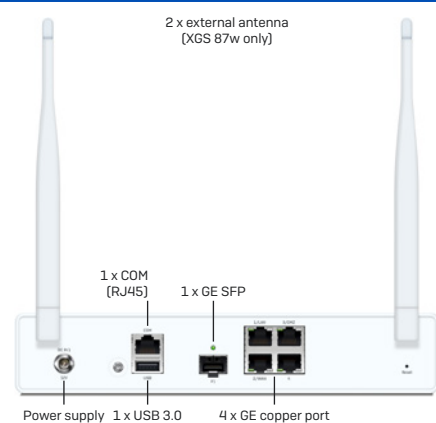

Physical Specifications

Mounting	Rackmount kit available (to be ordered separately)
Dimensions: Width X height X depth	230 x 44 x 205.5 mm
Weight	1.36 kg/3 lbs (unpacked) 2.75 kg/6.06 lbs (packed) (w-model minimally more)

Environment

Power supply	External auto-ranging AC-DC 100-240VAC, 1.7A@50-60 Hz 12VDC, 5A, 60W
Power consumption	23.2 W/79.16 BTU/hr (87 idle) 27.1 W/92.13 BTU/hr (87w idle) 43.4 W/148.09 BTU/hr (87 max.) 46.8 W/159.69 BTU/hr (87w max.)
Operating temperature	0°C to 40°C (operating) -20°C to +70°C (storage)
Humidity	10% to 90%, non-condensing

Product Certifications

Certifications	CB, CE, UKCA, UL, FCC, ISED, VCCI, CCC, KC*, BSMI, RCM, NOM, Anatel*, TEC
-----------------------	---

* XGS 87 only

Performance	XGS 87(w)
Firewall throughput	3,850 Mbps
Firewall IMIX	3,000 Mbps
Firewall Latency (64 byte UDP)	6 μ s
IPS throughput	1,200 Mbps
Threat protection throughput	850 Mbps
NGFW	700 Mbps
Concurrent connections	1,600,000
New connections/sec	35,700
IPsec VPN throughput	3,000 Mbps
IPsec VPN concurrent tunnels	500
SSL VPN concurrent tunnels	500
Xstream SSL/TLS Inspection	375 Mbps
Xstream SSL/TLS concurrent connections	8,192

Note: For performance testing methodology, see [page 10](#)

Wireless Specification (XGS 87w only)

No. of antennas	2 external
MIMO capabilities	2 x 2:2
Wireless interface	Wi-Fi 5 (802.11ac) 2.4 GHz/5 GHz

Physical Interfaces

Storage	16 GB eMMC
Ethernet interfaces (fixed)	4 x GE copper 1 x SFP fiber*
Management ports	1 x COM RJ45 1 x Micro-USB (cable incl.)
Other I/O ports	1 x USB 2.0 (front) 1 x USB 3.0 (rear)
Number of expansion slots	0
Optional add-on connectivity	SFP DSL module (VDSL2) SFP transceivers

* SFP transceivers sold separately

Sophos XGS Series Desktop: SMB and Branch Office

Gen.1: XGS 107, XGS 107w

Technical specifications

Front View



Back View

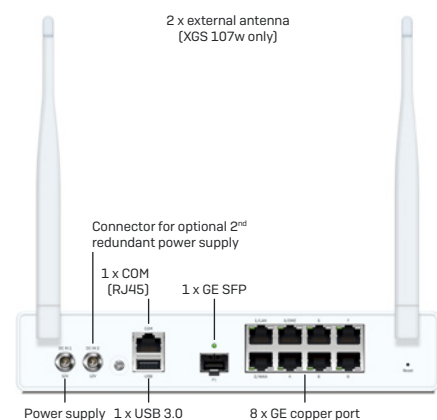

Physical Specifications

Mounting	Rackmount kit available (to be ordered separately)
Dimensions: Width X height X depth	230 x 44 x 205.5 mm
Weight	1.4 kg/3.09 lbs (unpacked) 2.8 kg/6.17 lbs (packed) (w-model minimally more)

Environment

Power supply	External auto-ranging AC-DC 100-240VAC, 1.7A@50-60 Hz 12VDC, 5A, 60W Optional second redundant power supply
Power consumption	26.1 W/89.06 BTU/hr (107 idle) 29.8 W/101.68 BTU/hr (107w idle) 53.9 W/183.91 BTU/hr (107 max.) 57.3 W/195.52 BTU/hr (107w max.)
Operating temperature	0°C to 40°C (operating) -20°C to +70°C (storage)
Humidity	10% to 90%, non-condensing

Product Certifications

Certifications	CB, CE, UKCA, UL, FCC, ISED, VCCI, CCC, KC*, BSMI, RCM, NOM, Anatel*, TEC, SDPPI*
-----------------------	---

* XGS 107 only

Performance	XGS 107(w)
Firewall throughput	7,000 Mbps
Firewall IMIX	3,750 Mbps
Firewall Latency (64 byte UDP)	6 μs
IPS throughput	1,500 Mbps
Threat Protection throughput	1,110 Mbps
NGFW	1,050 Mbps
Concurrent connections	1,600,000
New connections/sec	44,400
IPsec VPN throughput	4,000 Mbps
SSL VPN concurrent tunnels	1,000
IPsec VPN concurrent tunnels	1,000
Xstream SSL/TLS Inspection	420 Mbps
Xstream SSL/TLS concurrent connections	8,192

Note: For performance testing methodology, see [page 10](#)

Wireless Specification (XGS 107w only)

No. of antennas	2 external
MIMO capabilities	2 x 2:2
Wireless interface	Wi-Fi 5 (802.11ac) 2.4 GHz/5 GHz

Physical Interfaces

Storage (local quarantine/logs)	Integrated 64 GB SSD
Ethernet interfaces (fixed)	8 x GbE copper 1 x SFP fiber*
Management ports	1 x COM RJ45 1 x Micro-USB (cable incl.)
Other I/O ports	1 x USB 2.0 (front) 1 x USB 3.0 (rear)
Number of expansion slots	0
Optional add-on connectivity	SFP DSL module (VDSL2) SFP transceivers

* SFP transceivers sold separately

Sophos XGS Series Desktop: SMB and Branch Office

Gen.1: XGS 116, XGS 116w

Technical specifications

Front View



Back View

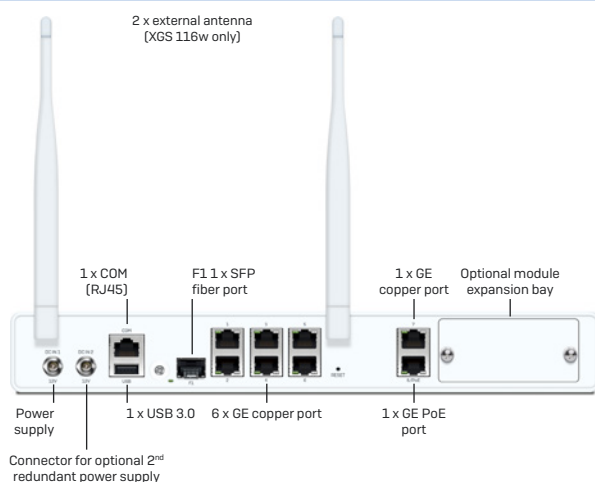

Physical Specifications

Mounting	Rackmount kit available (to be ordered separately)
Dimensions: Width X height X depth	320 x 44 x 213 mm
Weight	2.2 kg/4.85 lbs (unpacked) 4.2 kg/9.26 lbs (packed) (w-model minimally higher)

Environment

Power supply	External auto-ranging AC-DC 100-240VAC, 2.5A@50-60 Hz 12VDC, 12.5A, 150W Optional second redundant power supply
Power consumption	28 W/96 BTU/hr [116 idle] 30 W/102 BTU/hr [116w idle] 57 W/195 BTU/hr [116 max.] 60 W/205 BTU/hr [116w max.]
PoE addition enabled	38 W/130 BTU/hr (max.)
Operating temperature	0°C to 40°C (operating) -20°C to +70°C (storage)
Humidity	10% to 90%, non-condensing

Product Certifications

Certifications	CB, CE, UKCA, UL, FCC, ISED, VCCI, CCC, KC*, BSMI, RCM, NOM, Anatel*, TEC
-----------------------	---

* XGS 116 only

Performance	XGS 116(w)
Firewall throughput	7,700 Mbps
Firewall IMIX	4,500 Mbps
Firewall Latency (64 byte UDP)	8 µs
IPS throughput	2,500 Mbps
Threat Protection throughput	2,160 Mbps
NGFW	2,000 Mbps
Concurrent connections	1,600,000
New connections/sec	61,500
IPsec VPN throughput	4,800 Mbps
IPsec VPN concurrent tunnels	1,500
SSL VPN concurrent tunnels	1,250
Xstream SSL/TLS Inspection	650 Mbps
Xstream SSL/TLS concurrent connections	8,192

Note: For performance testing methodology, see [page 10](#)

Wireless Specification (XGS 116w only)

No. of antennas	2 external
MIMO capabilities	2 x 2:2
Wireless interface	Wi-Fi 5 (802.11a/b/g/n/ac) 2.4 GHz / 5 GHz
Optional second Wi-Fi module	Wi-Fi 5/802.11a/b/g/n/ac

Physical Interfaces

Storage (local quarantine/logs)	Integrated 64 GB SSD
Ethernet interfaces (fixed)	8 GE copper 1 GE SFP*
Power-over-Ethernet (fixed)	1 x GE 803.2at (30W max.)
Management ports	1 x COM RJ45 1 x Micro-USB (cable incl.)
Other I/O ports	1 x USB 2.0 (front) 1 x USB 3.0 (rear)
Number of expansion slots	1
Optional add-on connectivity	SFP DSL module (VDSL2) 3G/4G module/5G module Second Wi-Fi radio (XGS 116w only) SFP transceivers

* SFP transceivers sold separately

Sophos XGS Series Desktop: SMB and Branch Office

Gen.1: XGS 126, XGS 126w, XGS 136, XGS 136w

Technical specifications

Front View



Back View

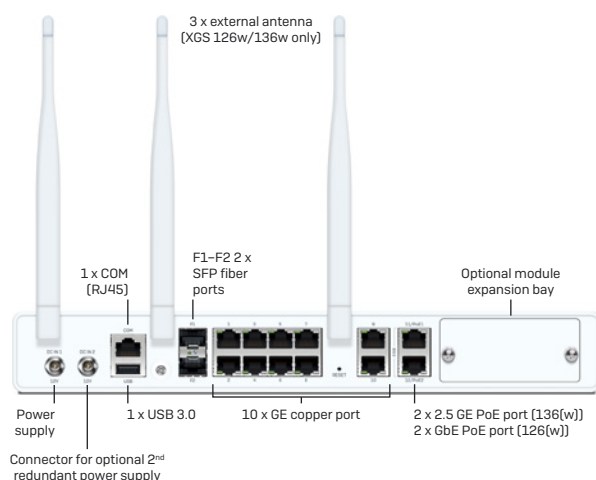

Physical Specifications

Mounting	Rackmount kit available (to be ordered separately)
Dimensions: Width X height X depth	320 x 44 x 213 mm
Weight	2.4 kg/5.29 lbs (unpacked) 4.4 kg/9.70 lbs (packed) (w-model minimally higher)

Environment

Power supply	External auto-ranging AC-DC 100-240VAC, 2.5A@50-60 Hz 12VDC, 12.5A, 150W Optional second redundant power supply
Power consumption	30 W/102 BTU/hr [126/136 idle] 32 W/109 BTU/hr [126w/136w idle] 59 W/202 BTU/hr [126 max.] 62 W/212 BTU/hr [126w/136 max.] 65 W/222 BTU/hr [136w max.]
PoE addition enabled	76 W/260 BTU/hr (max.)
Operating temperature	0°C to 40°C (operating) -20°C to +70°C (storage)
Humidity	10% to 90%, non-condensing

Product Certifications

Certifications	CB, CE, UKCA, UL, FCC, ISED, VCCI, CCC, KC†, BSMI, RCM, NOM, Anatel†, TEC, SDPPI†
-----------------------	---

* XGS 126 and XGS 136 only

† XGS 136 only

Performance	XGS 126(w)	XGS 136(w)
Firewall throughput	10,500 Mbps	11,500 Mbps
Firewall IMIX	5,250 Mbps	6,500 Mbps
Firewall Latency (64 byte UDP)	8 μs	8 μs
IPS throughput	3,250 Mbps	4,000 Mbps
Threat Protection throughput	2,700 Mbps	3,000 Mbps
NGFW	2,500 Mbps	3,000 Mbps
Concurrent connections	5,000,000	6,400,000
New connections/sec	69,900	74,500
IPsec VPN throughput	5,500 Mbps	6,350 Mbps
IPsec VPN concurrent tunnels	2,500	2,500
SSL VPN concurrent tunnels	1,500	1,500
Xstream SSL/TLS Inspection	800 Mbps	950 Mbps
Xstream SSL/TLS concurrent connections	12,288	18,432

Note: For performance testing methodology, see [page 10](#)

Wireless Specification (XGS 126w and XGS 136w only)

No. of antennas	3 external
MIMO capabilities	3 x 3:3
Wireless interface	Wi-Fi 5 (802.11a/b/g/n/ac) 2.4 GHz / 5 GHz
Optional 2nd Wi-Fi Module	Wi-Fi 5 (802.11a/b/g/n/ac)

Physical Interfaces

Storage (local quarantine/logs)	Integrated 64 GB SSD	
Ethernet interfaces (fixed)	12 x GE copper 2 x SFP fiber*	10 x GE copper 2 x 2.5 GE copper 2 x SFP fiber*
Power-over-Ethernet (fixed)	2 x GE (30W max. per port)	2 x 2.5 GE (30W max. per port)
Management ports	1 x COM RJ45 1 x Micro-USB (cable incl.)	
Other I/O ports	1 x USB 2.0 (front) 1 x USB 3.0 (rear)	
Number of expansion slots	1	
Optional add-on connectivity	SFP DSL module (VDSL2) 3G/4G module/5G module Second Wi-Fi radio (XGS 126w/136w only) SFP transceivers	

* SFP transceivers sold separately

Sophos XGS Series 1U: Distributed Edge

Mid-sized and distributed organizations that need a versatile solution to power and protect their networks will be well-served with our 1U models. These rackmount firewalls offer excellent performance, a diverse range of high-speed interfaces, and a choice of add-on connectivity modules. Whether your priority is ensuring maximum uptime for your SD-WAN links, securely connecting your remote users, or protecting your growing organization's network, you can tailor these models to your dynamic environment.

All models are powered by a high-speed CPU plus a dedicated Xstream Flow Processor for hardware acceleration.

Product highlights

- Dual processor architecture supports all key protection features without compromising performance
- Copper and fiber ports built in
- LAN bypass ports on every model
- Modular Flexi Port expansion bay(s) on every model to adapt connectivity
- Second power supply option for all models
- Centrally powered PoE Flexi Port module option to provide redundant power for PoE devices
- Rackmount kit included

Product highlights

XGS 2100

See detailed [technical specifications](#)

XGS 2300

See detailed [technical specifications](#)

XGS 3100

See detailed [technical specifications](#)

XGS 3300

See detailed [technical specifications](#)

XGS 4300

See detailed [technical specifications](#)

XGS 4500

See detailed [technical specifications](#)

LAN and WAN edge connectivity

Securely connect your branch offices or remote locations to your main office with Sophos SD-WAN, Remote Ethernet Devices, and add connectivity at the LAN edge with our access layer switches and access points. Find out more at the end of this brochure and sophos.com/switch.



Sophos XGS Series 1U: Distributed Edge

XGS 2100, XGS 2300

Technical specifications

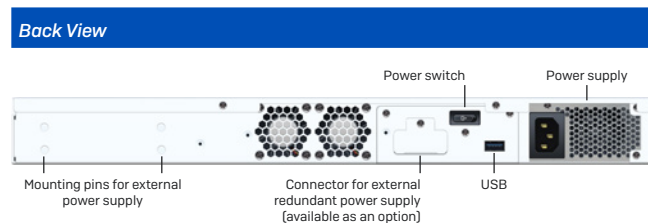
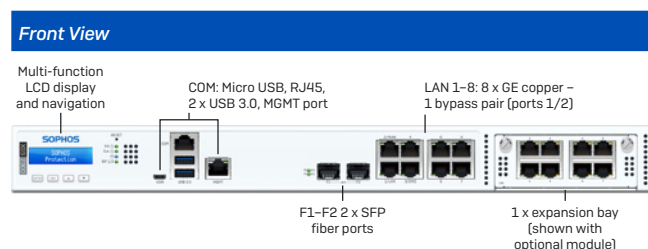

Physical Specifications

Mounting	1U rackmount (2 rackmount ears included)
Dimensions: Width X height X depth	438 x 44 x 405 mm
Weight	4.7 kg/10.36 lbs (unpacked) 7 kg/15.43 lbs (packed)

Environment

Power supply	Internal auto-ranging AC-DC 100-240VAC, 3-6A@50-60 Hz External Redundant PSU Option
Power consumption	43 W/146.86 BTU/hr [2100 idle] 45 W/153.7 BTU/hr [2300 idle] 162 W/533.5 BTU/hr [2100 max.] 167 W/570.74 BTU/hr [2300 max.]
PoE addition enabled	76 W/260 BTU/hr [max.]
Operating temperature	0°C to 40°C [operating] -20°C to +70°C [storage]
Humidity	10% to 90%, non-condensing

Product Certifications

Certifications	CB, CE, UKCA, UL, FCC, ISED, VCCI, KC, RCM, NOM, Anatel, CCC, BSMI, TEC, SDPPI
-----------------------	--

Performance	XGS 2100	XGS 2300
Firewall throughput	30,000 Mbps	39,000 Mbps
Firewall IMIX	16,500 Mbps	20,000 Mbps
Firewall Latency (64 byte UDP)	6 µs	4 µs
IPS throughput	6,000 Mbps	7,000 Mbps
Threat Protection throughput	5,000 Mbps	5,500 Mbps
NGFW	5,200 Mbps	6,300 Mbps
Concurrent connections	6,500,000	6,500,000
New connections/sec	134,700	148,000
IPsec VPN throughput	17,000 Mbps	20,500 Mbps
IPsec VPN concurrent tunnels	5,000	5,000
SSL VPN concurrent tunnels	2,500	2,500
Xstream SSL/TLS Inspection	1,100 Mbps	1,450 Mbps
Xstream SSL/TLS concurrent connections	18,432	18,432

Note: For performance testing methodology, see [page 10](#)

Physical Interfaces

Storage (local quarantine/logs)	Integrated min. 120 GB SATA-III SSD
Ethernet interfaces (fixed)	8 x GE copper 2 x SFP fiber*
Bypass port pairs	1
Management ports	1 x RJ45 MGMT 1 x COM RJ45 1 x Micro-USB (cable incl.)
Other I/O ports	2 x USB 3.0 (front) 1 x USB 2.0 (rear)
Number of Flexi Port slots	1
Flexi Port modules (optional)	8 port GE copper 8 port GE SFP fiber 4 port 10GE SFP+ fiber 4 port GE copper bypass (2 pairs) 4 port GE copper PoE + 4 port GE copper 4 port 2.5 GE copper PoE 2 port GE Fiber (LC) bypass + 4 port GE SFP Fiber
Max. total port density (incl. use of modules)	18
Max. Power-over-Ethernet (using Flexi Port module)	1 module: 4 ports, 60W max.
Optional add-on connectivity	SFP DSL module (VDSL2) SFP/SFP+ Transceivers
Display	Multi-function LCD module

* Transceivers (mini GBICs) sold separately

Sophos XGS Series 1U: Distributed Edge

XGS 3100, XGS 3300

Technical specifications

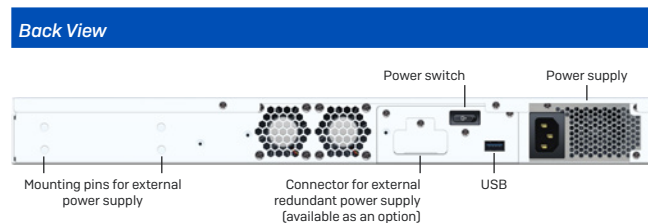
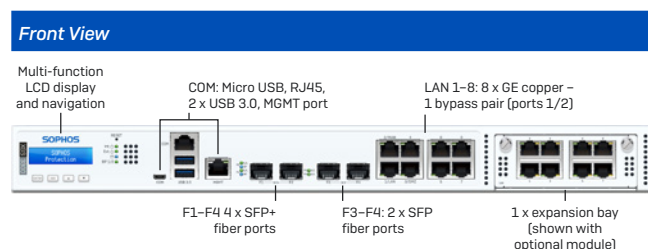

Physical Specifications

Mounting	1U rackmount (2 rackmount ears included)
Dimensions: Width X height X depth	438 x 44 x 405 mm
Weight	4.7 kg/10.36 lbs (unpacked) 7 kg/15.43 lbs (packed)

Environment

Power supply	Internal auto-ranging AC-DC 100-240VAC, 3-6A@50-60 Hz External Redundant PSU Option
Power consumption	50 W/170.77 BTU/hr [3100 idle] 50 W/170.77 BTU/hr [3300 idle] 182 W/621.97 BTU/hr [3100 max.] 201 W/686.68 BTU/hr [3300 max.]
PoE addition enabled	76 W/260 BTU/hr (max.)
Operating temperature	0°C to 40°C [operating] -20°C to +70°C [storage]
Humidity	10% to 90%, non-condensing

Product Certifications

Certifications	CB, CE, UKCA, UL, FCC, ISED, VCCI, KC, RCM, NOM, Anatel, CCC, BSMI, TEC, SDPPI
-----------------------	--

Performance	XGS 3100	XGS 3300
Firewall throughput	47,000 Mbps	58,000 Mbps
Firewall IMIX	23,500 Mbps	27,000 Mbps
Firewall Latency (64 byte UDP)	4 µs	4 µs
IPS throughput	10,500 Mbps	14,000 Mbps
Threat Protection throughput	7,400 Mbps	10,000 Mbps
NGFW	9,000 Mbps	12,500 Mbps
Concurrent connections	12,260,000	13,700,000
New connections/sec	186,500	257,800
IPsec VPN throughput	25,000 Mbps	31,100 Mbps
IPsec VPN concurrent tunnels	6,500	6,500
SSL VPN concurrent tunnels	5,000	5,000
Xstream SSL/TLS Inspection	2,470 Mbps	3,130 Mbps
Xstream SSL/TLS concurrent connections	55,296	102,400

Note: For performance testing methodology, see [page 10](#)

Physical Interfaces

Storage (local quarantine/logs)	Integrated min. 240 GB SATA-III SSD
Ethernet interfaces (fixed)	8 x GE copper 2 x SFP fiber* 2 x SFP+ 10 GE fiber*
Bypass port pairs	1
Management ports	1 x RJ45 MGMT 1 x COM RJ45 1 x Micro-USB (cable incl.)
Other I/O ports	2 x USB 3.0 (front) 1 x USB 2.0 (rear)
Number of Flexi Port slots	1
Flexi Port modules (optional)	8 port GE copper 8 port GE SFP fiber 4 port 10 GE SFP+ fiber 4 port GE copper bypass (2 pairs) 4 port GE copper PoE + 4 port GE copper 4 port 2.5 GE copper PoE 2 port GbE Fiber (LC) bypass + 4 port GE SFP Fiber
Max. total port density (incl. use of modules)	20
Max. Power-over-Ethernet (using Flexi Port module)	1 module: 4 ports, 60W max.
Optional add-on connectivity	SFP DSL module (VDSL2) SFP/SFP+ Transceivers
Display	Multi-function LCD module

* Transceivers (mini GBICs) sold separately

Sophos XGS Series 1U: Distributed Edge

XGS 4300

Technical specifications

Front View

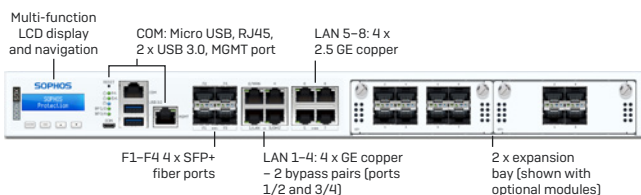

Back View

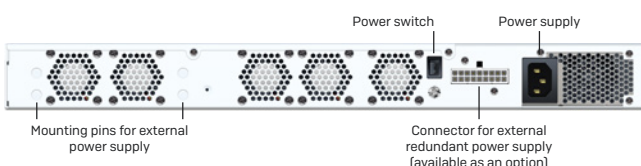

Physical Specifications

Mounting	1U rackmount (sliding rails incl.)
Dimensions: Width X height X depth	438 x 44 x 510 mm
Weight	8.7 kg/19.18 lbs (unpacked) 14.9 kg/32.85 lbs (packed)

Environment

Power supply	Internal auto-ranging AC-DC 100-240VAC, 3.7-7.4A@50-60 Hz External Redundant PSU Option
Power consumption	131 W/447.43 BTU/hr (idle) 268.35 W/916.56 BTU/hr (max.)
PoE addition enabled	152 W/519 BTU/hr
Operating temperature	0°C to 40°C (operating) -20 to +70°C (storage)
Humidity	10% to 90%, non-condensing

Product Certifications

Certifications	CB, CE, UKCA, UL, FCC, ISED, VCCI, KC, RCM, NOM, Anatel, CCC, BSMI, TEC, SDPPI
-----------------------	--

Performance	XGS 4300
Firewall throughput	75,000 Mbps
Firewall IMIX	33,000 Mbps
Firewall Latency (64 byte UDP)	3 µs
IPS throughput	29,500 Mbps
Threat Protection throughput	25,200 Mbps
NGFW	23,000 Mbps
Concurrent connections	16,600,000
New connections/sec	368,000
IPsec VPN throughput	62,500 Mbps
IPsec VPN concurrent tunnels	8,500
SSL VPN concurrent tunnels	7,500
Xstream SSL/TLS Inspection	8,000 Mbps
Xstream SSL/TLS concurrent connections	276,480

Note: For performance testing methodology, see [page 10](#)

Physical Interfaces

Storage (local quarantine/logs)	1 x min. 240 GB SATA-III SSD
Ethernet interfaces (fixed)	4 x GE copper 4 x 2.5 GE copper 4 x SFP+ 10 GE fiber*
Bypass port pairs	2
Management ports	1 x RJ45 MGMT 1 x COM RJ45 1 x Micro-USB (cable incl.)
Other I/O ports	2 x USB 3.0 (front)
Number of Flexi Port slots	2
Flexi Port modules (optional)	8 port GE copper 8 port GE SFP fiber 4 port 10 GE SFP+ fiber 4 port GbE copper bypass (2 pairs) 4 port GE copper PoE + 4 port GE copper 4 port 2.5 GE copper PoE 2 port GE Fiber (LC) bypass + 4 port GE SFP Fiber
Max. total port density (incl. use of modules)	28
Max. Power-over-Ethernet (using Flexi Port module)	2 modules: 4 ports, 60W max. each
Optional add-on connectivity	SFP DSL module (VDSL2) SFP/SFP+ Transceivers
Display	Multi-function LCD module

* Transceivers (mini GBICs) sold separately

Sophos XGS Series 1U: Distributed Edge

XGS 4500

Technical specifications

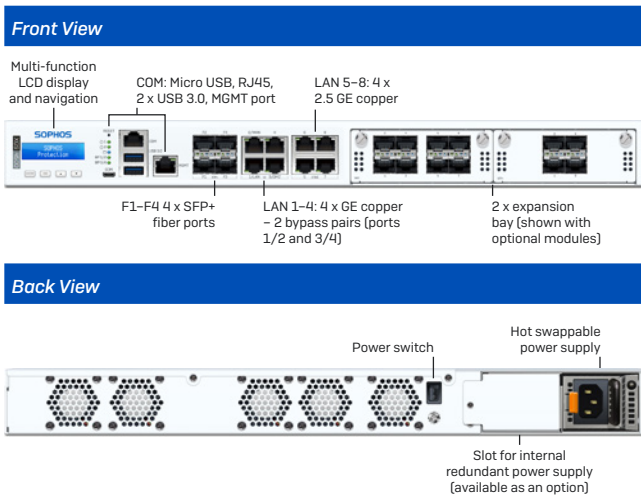

Physical Specifications

Mounting	1U rackmount (sliding rails incl.)
Dimensions: Width X height X depth	438 x 44 x 510 mm
Weight	9.7 kg/21.38 lbs (unpacked) 15.9 kg/35.05 lbs (packed)

Environment

Power supply	Internal Hot Swappable auto-ranging AC-DC 100-240VAC, 3.7-7.4A@50-60 Hz Internal Redundant PSU Option
Power consumption	151 W/515.74 BTU/hr (idle) 268.35 W/916.56 BTU/hr (max.)
PoE addition enabled	152 W/519 BTU/hr
Operating temperature	0°C to 40°C (operating) -20 to +70°C (storage)
Humidity	10% to 90%, non-condensing

Product Certifications

Certifications	CB, CE, UKCA, UL, FCC, ISED, VCCI, KC, RCM, NOM, Anatel, CCC, BSMI, TEC, SDPPI
-----------------------	--

Performance	XGS 4500
Firewall throughput	80,000 Mbps
Firewall IMIX	37,000 Mbps
Firewall Latency (64 byte UDP)	4 µs
IPS throughput	36,500 Mbps
Threat Protection throughput	31,850 Mbps
NGFW	30,000 Mbps
Concurrent connections	17,200,000
New connections/sec	450,000
IPsec VPN throughput	75,550 Mbps
IPsec VPN concurrent tunnels	8,500
SSL VPN concurrent tunnels	10,000
Xstream SSL/TLS Inspection	10,600 Mbps
Xstream SSL/TLS concurrent connections	276,480

Note: For performance testing methodology, see [page 10](#)

Physical Interfaces

Storage (local quarantine/logs)	2 x min. 240 GB SATA-III SSD (SW RAID-1)
Ethernet interfaces (fixed)	4 x GE copper 4 x 2.5 GE copper 4 x SFP+ 10 GE fiber*
Bypass port pairs	2
Management ports	1 x RJ45 MGMT 1 x COM RJ45 1 x Micro-USB (cable incl.)
Other I/O ports	2 x USB 3.0 (front)
Number of Flexi Port slots	2
Flexi Port modules (optional)	8 port GE copper 8 port GE SFP fiber 4 port 10 GE SFP+ fiber 4 port GE copper bypass (2 pairs) 4 port GE copper PoE + 4 port GE copper 4 port 2.5 GE copper PoE 2 port GE Fiber (LC) bypass + 4 port GE SFP Fiber
Max. total port density (incl. use of modules)	28
Max. Power-over-Ethernet (using Flexi Port module)	2 modules: 4 ports, 60W max. each
Optional add-on connectivity	SFP DSL module (VDSL2) SFP/SFP+ Transceivers
Display	Multi-function LCD module

* Transceivers (mini GBICs) sold separately

Sophos XGS Series 2U: Enterprise and Campus Edge

These next-gen firewalls provide no-compromise protection, performance, and business continuity to distributed and growing enterprises that require maximum throughput for even the most complex networks. The Xstream Flow Processors provide dedicated hardware acceleration to easily handle full-on protection for today's encrypted, cloud-hosted applications and traffic. These models strike the perfect balance between port density and modularity, with a range of high-speed, built-in ports, plus additional high-density Flexi Port modules available to extend connectivity even further.

All models are powered by a high-speed CPU plus a dedicated Xstream Flow Processor for enterprise-grade hardware acceleration.

Product highlights

- Dual-processor architecture with dedicated co-processor for hardware acceleration
- Built to power all key threat protection features such as TLS inspection, sandboxing, and AI-driven threat analysis
- Excellent price-to-performance ratio
- A range of standard 1 GE copper plus 8 to 12 SFP+ 10 GE fiber interfaces built in
- QSPF28 ports on the XGS 7500 and 8500 provide port speeds of up to 40 Gbps (7500) and 100 Gbps (8500)
- Optional standard and high-density Flexi Port modules available to extend and adapt connectivity
- Maximum port density of 48 (XGS 5500), 68 (XGS 6500), or 70 (XGS 7500/8500) using optional modules
- Redundancy features on all models ensure business continuity

Product highlights

XGS 5500

See detailed [technical specifications](#)

XGS 6500

See detailed [technical specifications](#)

XGS 7500

See detailed [technical specifications](#)

XGS 8500

See detailed [technical specifications](#)

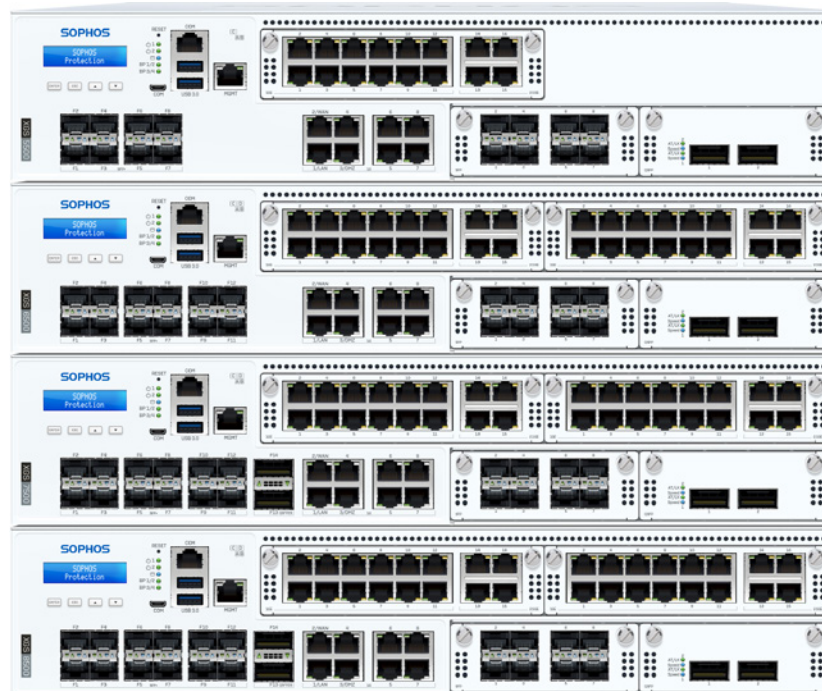

Sophos XGS Series 2U: Enterprise Edge

XGS 5500

Technical specifications

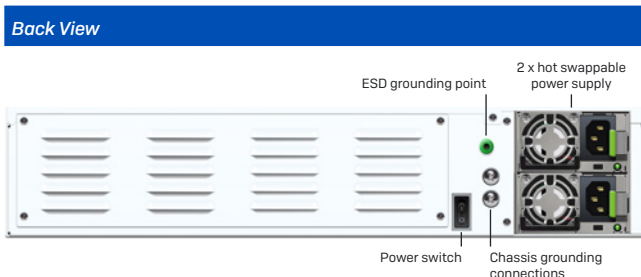
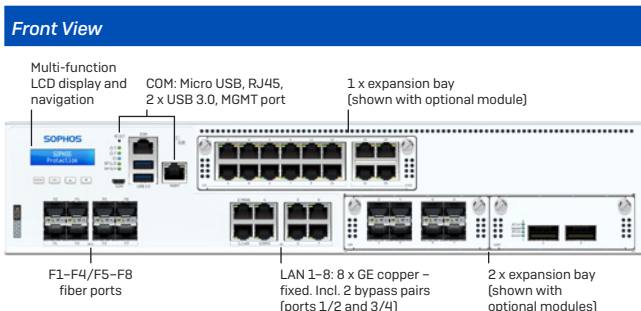

Physical Specifications

Mounting	2U sliding rails (included)
Dimensions: Width X height X depth	438 x 88 x 645 mm
Weight	17.8 kg/39.24 lbs (unpacked) 27 kg/59.53 lbs (packed)

Environment

Power supply	2 x hot-swap internal auto-ranging 100-240VAC, 50-60 Hz PSU
Power consumption	168.0W/573.81 BTU/h (idle) 478.01W/1117.43 BTU/h (max.)
Operating temperature	0°C to 40°C (operating) -20°C to +70°C (storage)
Humidity	10% to 90%, non-condensing

Product Certifications

Certifications	CB, CE, UKCA, UL, FCC, ISED, VCCI, BSMI, RCM, NOM, Anatel, KC, CCC, SDPPI Planned: TEC
-----------------------	---

Performance	XGS 5500
Firewall throughput	100,000 Mbps
Firewall IMIX	52,000 Mbps
Firewall Latency (64 byte UDP)	5 μs
IPS throughput	40,000 Mbps
Threat Protection throughput	46,000 Mbps
NGFW	38,000 Mbps
Concurrent connections	32,400,000
New connections/sec	468,000
IPsec VPN throughput	92,500 Mbps
IPsec VPN concurrent tunnels	10,000
SSL VPN concurrent tunnels	15,000
Xstream SSL/TLS Inspection	13,500 Mbps
Xstream SSL/TLS concurrent connections	512,000

Note: For performance testing methodology, see [page 10](#)

Physical Interfaces

Storage (local quarantine/logs)	2 x min. 480 GB SATA-III SSD HW RAID built into CPU
Ethernet interfaces (fixed)	8 x GE copper 8 x SFP+ 10 GE fiber*
Bypass port pairs	2
Management ports	1 x RJ45 MGMT 1 x COM RJ45 1 x Micro-USB (cable incl.)
Other I/O ports	2 x USB 3.0 (front)
Number of Flexi Port slots	2 + 1 for high-density module
Flexi Port modules (optional)	8 port GE copper 8 port GE SFP fiber 4 port 10 GE SFP+ fiber 4 port GbE copper bypass (2 pairs) 2 port 40 GE QSFP+ fiber 8 port 10 GE SFP+ fiber 2 port GbE Fiber (LC) bypass + 4 port GE SFP Fiber 2 port 10 GE Fiber (LC) bypass + 4 port 10 GE SFP+ Fiber High-density module (NIC): 12 port GE copper + 4 port 2.5 GE copper
Max. total port density (incl. use of modules)	48
Optional add-on connectivity	SFP DSL module (VDSL2) SFP/SFP+ Transceivers
Display	Multi-function LCD module

* Transceivers (mini GBICs) sold separately

Sophos XGS Series 2U: Enterprise Edge

XGS 6500

Technical specifications

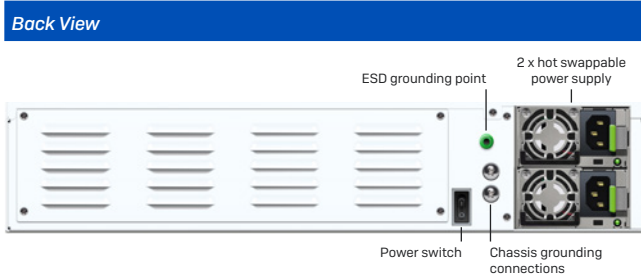
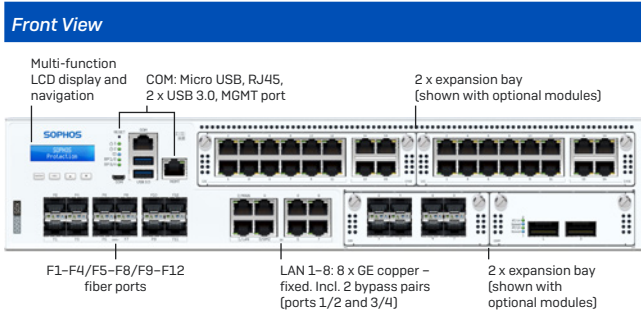

Physical Specifications

Mounting	2U sliding rails (included)
Dimensions: Width X height X depth	438 x 88 x 645 mm
Weight	17.8 kg/39.24 lbs (unpacked) 27 kg/59.53 lbs (packed)

Environment

Power supply	2 x hot-swap internal auto-ranging 100-240VAC, 50-60 Hz PSU
Power consumption	188.00 W/642.13 BTU/h (idle) 497.09 W/1697.8 BTU/h (max.)
Operating temperature	0°C to 40°C (operating) -20°C to +70°C (storage)
Humidity	10% to 90%, non-condensing

Product Certifications

Certifications	CB, CE, UKCA, UL, FCC, ISED, VCCI, BSMI, RCM, NOM, Anatel, KC, CCC, SDPPI Planned: TEC
-----------------------	---

Performance	XGS 6500
Firewall throughput	120,000 Mbps
Firewall IMIX	60,000 Mbps
Firewall Latency (64 byte UDP)	5 µs
IPS throughput	50,750 Mbps
Threat Protection throughput	53,500 Mbps
NGFW	46,500 Mbps
Concurrent connections	39,900,000
New connections/sec	496,000
IPsec VPN throughput	109,800 Mbps
IPsec VPN concurrent tunnels	10,000
SSL VPN concurrent tunnels	15,000
Xstream SSL/TLS Inspection	16,000 Mbps
Xstream SSL/TLS concurrent connections	768,000

Note: For performance testing methodology, see [page 10](#)

Physical Interfaces

Storage (local quarantine/logs)	2 x min. 480 GB SATA-III SSD HW RAID built into CPU
Ethernet interfaces (fixed)	8 x GE copper 12 x SFP+ 10 GE fiber*
Bypass port pairs	2
Management ports	1 x RJ45 MGMT 1 x COM RJ45 1 x Micro-USB (cable incl.)
Other I/O ports	2 x USB 3.0 (front)
Number of Flexi Port slots	2 + 2 for high-density module
Flexi Port modules (optional)	8 port GE copper 8 port GE SFP fiber 4 port 10 GE SFP+ fiber 4 port GE copper bypass (2 pairs) 2 port 40 GE QSFP+ fiber 8 port 10 GE SFP+ fiber 2 port GbE Fiber (LC) bypass + 4 port GE SFP Fiber 2 port 10 GE Fiber (LC) bypass + 4 port 10 GE SFP+ Fiber High-density module (NIC): 12 port GE copper + 4 port 2.5 GE copper
Max. total port density (incl. use of modules)	68
Optional add-on connectivity	SFP DSL module (VDSL2) SFP/SFP+ Transceivers
Display	Multi-function LCD module

* Transceivers (mini GBICs) sold separately

Sophos XGS Series 2U: Enterprise/Campus Edge

XGS 7500

Technical specifications

Front View

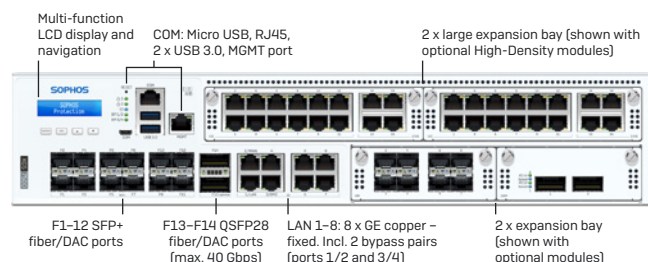

Back View



Physical Specifications

Mounting	2U sliding rails (included)
Dimensions: Width X height X depth	438 x 88 x 645 mm 17.24 x 3.46 x 25.39 inches
Weight	18 kg/39.68 lbs (unpacked) 27.3 kg/60.19 lbs (packed)

Environment

Power supply	2 x hot-swap internal auto-ranging 100-240VAC, 50-60 Hz PSU
Power consumption	306 W/1,044 BTU/h (idle) 635 W/2,165 BTU/h (max.)
Operating temperature	0°C to 40°C (operating) -20°C to +70°C (storage)
Humidity	10% to 90%, non-condensing

Product Certifications

Certifications	CB, CE, UKCA, UL, FCC, ISED, VCCI, BSMI, RCM, NOM, KC, SDPPI, Anatel, CCC. Planned: TEC
-----------------------	--

Performance	XGS 7500
Firewall throughput	160,000 Mbps
Firewall IMIX	70,500 Mbps
Firewall Latency (64 byte UDP)	5.4 µs
IPS throughput	71,500 Mbps
Threat Protection throughput	70,000 Mbps
NGFW	58,000 Mbps
Concurrent connections	48,000,000
New connections/sec	1,100,000
IPsec VPN throughput	117,000 Mbps
IPsec VPN concurrent tunnels	12,500
SSL VPN concurrent tunnels	19,000
Xstream SSL/TLS Inspection	19,500 Mbps
Xstream SSL/TLS concurrent connections	1,280,000

Note: For performance testing methodology, see [page 10](#)

Physical Interfaces

Storage (local quarantine/logs)	2 x min. 960 GB NVMe SSD HW RAID built into CPU
Ethernet interfaces (fixed)	8 x GbE copper 12 x SFP+ 10 GbE fiber* 2 x QSFP28 (up to 40 Gbps)
Bypass port pairs	2
Management ports	1 x RJ45 MGMT 1 x COM RJ45 1 x Micro-USB (cable incl.)
Other I/O ports	2 x USB 3.0 (front)
Number of Flexi Port slots	2 + 2 for high-density module
Flexi Port modules (optional)	8 port GE copper 8 port GE SFP fiber 4 port 10 GE SFP+ fiber 4 port GE copper bypass (2 pairs) 2 port 40 GE QSFP+ fiber 8 port 10 GE SFP+ fiber 2 port GE Fiber (LC) bypass + 4 port GE SFP Fiber 2 port 10 GE Fiber (LC) bypass + 4 port 10 GE SFP+ Fiber High-density module (NIC): 12 port GE copper + 4 port 2.5 GE copper
Max. total port density (incl. use of modules)	70
Optional add-on connectivity	SFP DSL module (VDSL2) SFP/SFP+ Transceivers
Display	Multi-function LCD module

* Transceivers (mini GBICs) sold separately

Sophos XGS Series 2U: Enterprise/Campus Edge

XGS 8500

Technical specifications

Front View

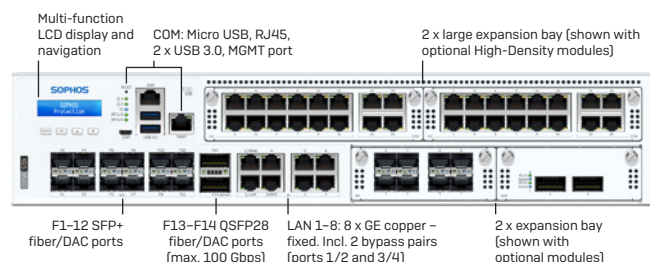

Back View

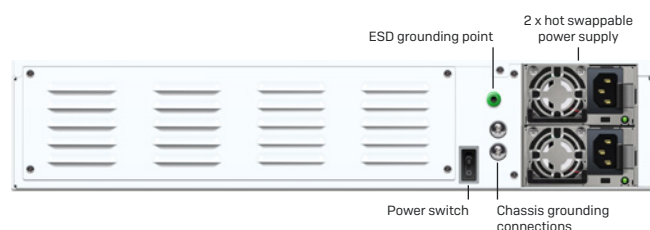

Physical Specifications

Mounting	2U sliding rails (included)
Dimensions: Width X height X depth	438 x 88 x 645 mm 17.24 x 3.46 x 25.39 inches
Weight	18 kg/39.68 lbs (unpacked) 27.3 kg/60.19 lbs (packed)

Environment

Power supply	2 x hot-swap internal auto-ranging 100-240VAC, 50-60 Hz PSU
Power consumption	318 W/1,085 BTU/h [idle] 645 W/2,200 BTU/h [max.]
Operating temperature	0°C to 40°C (operating) -20°C to +70°C (storage)
Humidity	10% to 90%, non-condensing

Product Certifications

Certifications	CB, CE, UKCA, UL, FCC, ISED, VCCI, BSMI, RCM, NOM, KC, SDPPI, Anatel, CCC. Planned: TEC
-----------------------	--

Performance	XGS 8500
Firewall throughput	190,000 Mbps
Firewall IMIX	81,000 Mbps
Firewall Latency (64 byte UDP)	5.5 μ s
IPS throughput	93,000 Mbps
Threat Protection throughput	92,500 Mbps
NGFW	76,000 Mbps
Concurrent connections	58,000,000
New connections/sec	1,700,000
IPsec VPN throughput	141,000 Mbps
IPsec VPN concurrent tunnels	15,000
SSL VPN concurrent tunnels	24,000
Xstream SSL/TLS Inspection	24,000 Mbps
Xstream SSL/TLS concurrent connections	2,500,000

Note: For performance testing methodology, see [page 10](#)

Physical Interfaces

Storage (local quarantine/logs)	2 x min. 960 GB NVMe SSD HW RAID built into CPU
Ethernet interfaces (fixed)	8 x GE copper 12 x SFP+ 10 GE fiber* 2 x QSFP28 (up to 100 Gbps)
Bypass port pairs	2
Management ports	1 x RJ45 MGMT 1 x COM RJ45 1 x Micro-USB (cable incl.)
Other I/O ports	2 x USB 3.0 (front)
Number of Flexi Port slots	2 + 2 for high-density module
Flexi Port modules (optional)	8 port GE copper 8 port GE SFP fiber 4 port 10 GE SFP+ fiber 4 port GE copper bypass (2 pairs) 2 port 40 GE QSFP+ fiber 8 port 10 GE SFP+ fiber 2 port GE Fiber (LC) bypass + 4 port GE SFP Fiber 2 port 10 GE Fiber (LC) bypass + 4 port 10 GE SFP+ Fiber High-density module (NIC): 12 port GE copper + 4 port 2.5 GE copper
Max. total port density (incl. use of modules)	70
Optional add-on connectivity	SFP DSL module (VDSL2) SFP/SFP+ Transceivers
Display	Multi-function LCD module



* Transceivers (mini GBICs) sold separately

Adapt Connectivity with Optional Modules

Connectivity modules

Add additional connectivity options to your appliances to enhance the range and performance of your network.

XGS Series: Optional connectivity modules

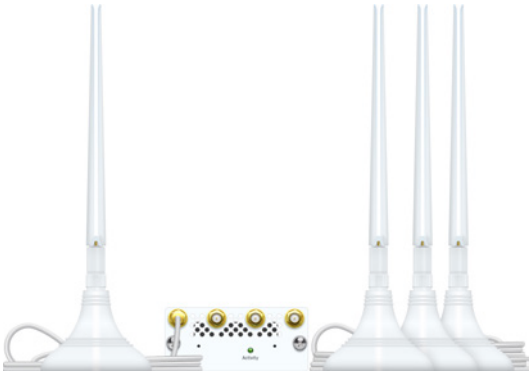
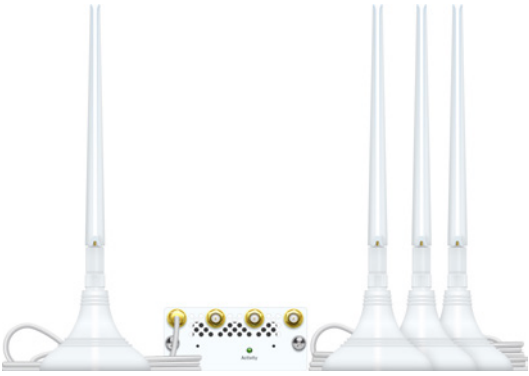
Desktop Modules		Other Connectivity Options
 <p>2nd Wi-Fi 5 Module For XGS 116w, 126w, and 136w only (not compatible with XG Series)</p>	 <p>3G/4G Module For XGS 116(w), 126(w), and 136(w) models only (not compatible with XG Series)</p>	<p>Optional Transceivers A range of optional transceivers are available, incl. SFP, SFP+</p>
 <p>5G Module (Gen.1) For XGS 116(w), 126(w), and 136(w) models only (not compatible with XG Series)</p>	 <p>5G Module (Gen.2) For XGS 118(w), XGS 128(w), XGS 138 (not compatible with Gen.1 XGS or XG Series)</p>	

XGS Series: Gen.2 Desktop accessory matrix by model

	Redundancy	Connectivity			Mounting
Model	Power	Expansion Bay	5G module	Wi-Fi Options	Rackmount Kit
XGS 88	n/a	n/a	n/a	n/a	Optional
XGS 88w				Built in	
XGS 108	Optional 2 nd power supply	1	Optional	n/a	
XGS 108w				Built in	
XGS 118				n/a	
XGS 118w				Built in	
XGS 128				n/a	
XGS 128w				Built in	
XGS 138				n/a	











XGS Series: Gen.1 Desktop accessory matrix by model

	Redundancy	Connectivity			Mounting
Model	Power	Expansion Bay	3G/4G/5G module	Wi-Fi Options	Rackmount Kit
XGS 87	n/a	n/a	n/a	n/a	Optional
XGS 87w				Built in	
XGS 107	Optional 2 nd power supply	1	Optional	n/a	
XGS 107w				Built in	
XGS 116				n/a	
XGS 116w				Built in Optional 2 nd module	
XGS 126				n/a	
XGS 126w				Built in Optional 2 nd module	
XGS 136	n/a				
XGS 136w	Built in Optional 2 nd module				



Flexi Port modules for 1U and 2U

Configure your hardware to suit your infrastructure and change it as needed. Our optional Flexi Port LAN modules give you the freedom to select the connectivity you need. Copper, fiber, 10 GE, and 40 GE – you decide.

<i>XGS Rackmount Models</i>	<i>For XGS 2xxx/3xxx/4xxx only</i>	<i>For XGS 2U Rackmount Models only</i>
 <p>8 Port 1G copper</p>	 <p>4 Port 1G copper PoE + 4 Port 1G copper</p>	 <p>2 Port 40G QSFP+</p>
 <p>8 Port 1G SFP</p>	 <p>4 Port 2.5G copper PoE</p>	 <p>8 Port 10G SFP+</p>
 <p>4 Port 10G SFP+</p>		 <p>2 port 10 GE Fiber (LC) bypass + 4 port 10 GE SFP+ Fiber</p>
 <p>4 Port 1G copper bypass (2 pairs)</p>		 <p>High-Density Flexi Port Module (NIC) 12 Port 1G copper + 4 Port 2.5G copper</p>
 <p>2 port GE Fiber (LC) bypass + 4 port GE SFP Fiber</p>		

Note: XGS modules are not compatible with any previous XG Series appliances

XGS Series: 1U Accessory matrix by model

Model	Redundancy		Modular Connectivity			Mounting
	Power	2 nd SSD	VDSL SFP Modem	Flexi Port Bays	Flexi Port Modules	Rackmount Kit
XGS 2100	Optional external	n/a	Optional	1	<ul style="list-style-type: none"> ▸ 8 Port 1G copper ▸ 8 Port 1G SFP ▸ 4 Port 10G SFP+ ▸ 4 Port 1G copper bypass ▸ 4 port 1G copper PoE ▸ + 4 port 1G copper ▸ 4 port 2.5G copper PoE ▸ 2 port GE Fiber (LC) bypass + 4 port GE SFP Fiber 	Rackmount ears incl. Optional sliding rails
XGS 2300	Optional external	n/a	Optional	1		Rackmount ears incl. Optional sliding rails
XGS 3100	Optional external	n/a	Optional	1		Rackmount ears incl. Optional sliding rails
XGS 3300	Optional external	n/a	Optional	1		Rackmount ears incl. Optional sliding rails
XGS 4300	Optional external	n/a	Optional	2		Sliding rails included
XGS 4500	Optional internal	Internal redundant SSD	Optional	2		Sliding rails included

XGS Series: 2U Accessory matrix by model

Model	Redundancy		Modular Connectivity			Mounting
	Power	SSD	VDSL SFP Modem	Flexi Port Bays	Flexi Port Modules	Rackmount Kit
XGS 5500	Included	2 nd redundant SSD included	Optional	2 + 1 for High-density module	<ul style="list-style-type: none"> ▸ 8 Port 1G copper ▸ 8 Port 1G SFP ▸ 4 Port 10G SFP+ ▸ 4 Port 1G copper bypass ▸ 2 port 40G QSFP+ ▸ 8 port 10G SFP+ ▸ 2 port GE Fiber (LC) bypass + 4 port GE SFP Fiber ▸ 2 port 10 GE Fiber (LC) bypass + 4 port 10 GE SFP+ Fiber ▸ High-Density Flexi Port module (NIC) 12 Port 1G copper + 4 Port 2.5G copper 	Sliding rails included
XGS 6500	Included	2 nd redundant SSD included	Optional	2 + 2 for High-density modules		Sliding rails included
XGS 7500	Included	2 nd redundant NVMe SSD included	Optional	2 + 2 for High-density modules		Sliding rails included
XGS 8500	Included	2 nd redundant NVMe SSD included	Optional	2 + 2 for High-density modules		Sliding rails included

Sophos Wireless Protection

Simple. Secure. Reliable.

Sophos offers three different options for wireless protection:

Cloud-managed Wi-Fi (our recommendation)

Sophos Wireless is our Sophos Central-managed Wi-Fi solution. It offers the broadest feature set, the best scalability, and support for the latest generation of Wi-Fi 6/6E access points, the AP6 Series.

AP6 Series models

- AP6 420 – 2x2 indoor Wi-Fi 6
- AP6 420E – 2x2 indoor Wi-Fi 6/6E
- AP6 840 – 4x4 indoor Wi-Fi 6
- AP6 840E – 4x4 indoor Wi-Fi 6/6E
- AP6 420X – 2x2 outdoor Wi-Fi 6

All models come with a limited lifetime warranty.

Sophos Central management of AP6

A support subscription is required to manage an AP6 Series access point in Sophos Central which also unlocks additional benefits and features (e.g., advanced RMA, Active Threat Response).

Local management of AP6

Each AP6 Series includes a local management option that does not require an additional subscription.

As a single management platform for all of your Sophos security solutions, Sophos Central puts your Wi-Fi management just one click away from your firewalls and switches, endpoint and server security, email protection, and more.

Learn more about our cloud-managed Wi-Fi at sophos.com/wireless

Hardware appliances with integrated Wi-Fi

All of our XGS Series desktop appliances are available with an integrated wireless access point. This option is ideal for small environments such as retail outlets where an all-in-one solution is preferred.

Firewall as a controller

This option supports our end-of-sale Wi-Fi 5 APX Series access points only.

Using Sophos Firewall as a wireless controller, supported Sophos access points are automatically discovered when they're connected, allowing you to configure a variety of corporate, guest, or contractor wireless networks quickly and easily.



SD-RED



Sophos SD-RED: Empowering your SD-WAN strategy

Sophos has long been a pioneer in providing an easy-to-use and secure way to connect branch offices and other remote locations. Sophos Firewall includes comprehensive SD-WAN features to help you accelerate application performance and get better visibility into network health to ensure that your remote locations enjoy the same performance as your main office.

Our SD-RED devices work with your Sophos Firewall independent of whether you have a hardware, software, or public cloud deployment. Our APX Series access points are also compatible with Sophos SD-RED.

To manage Sophos SD-RED, you need to have an active Network Protection subscription on your firewall.

Technical specifications

Model	SD-RED 20	SD-RED 60
		
Capacity		
Maximum tunnel throughput	250 Mbps	850 Mbps
Physical interfaces (Built-in)		
LAN interfaces	4 x 10/100/1000 Base-TX (1 GE copper)	4 x 10/100/1000 Base-TX (1 GE copper)
WAN interfaces	1 x 10/100/1000 Base-TX (shared with SFP)	2 x 10/100/1000 Base-TX (WAN1 shared port with SFP)
SFP interfaces	1x SFP fiber (shared port with WAN)	1x SFP fiber (shared port with WAN1)
Power-over-Ethernet ports	None	2 PoE ports (total power 30W)
USB ports	2 x USB 3.0 (front and rear)	2 x USB 3.0 (front and rear)
COM ports	1 x micro-USB	1 x micro-USB
Optional Connectivity		
Modular bay	1 (for use with optional Wi-Fi OR 4G/LTE card)	1 (for use with optional Wi-Fi OR 4G/LTE card)
Optional Wi-Fi module	Wi-Fi 5 (802.11ac) dual-band capable 2 x 2 MIMO 2 antennas	Wi-Fi 5 (802.11 ac) dual-band capable 2 x 2 MIMO 2 antennas
Optional 3G/4G LTE module	MC7430/MC7455 Sierra Wireless Card	MC7430/MC7455 Sierra Wireless Card
Physical Specifications		
Dimensions: Width x height x depth	225 x 44 x 150 mm 8.86 x 1.73 x 5.91 inches	225 x 44 x 150 mm 8.86 x 1.73 x 5.91 inches
Weight	0.9 kg/1.8 kg (1.98 lbs/3.97 lbs) Unpacked/Packed	1.0 kg/2.2 kg (2.2 lbs/4.85 lbs) Unpacked/Packed
Power supply adapter	AC Input: 110-240VAC @50-60 Hz DC Output: 12V +/- 10%, 3.7A, 40W	AC Input: 110-240VAC @50-60 Hz DC Output: 12V +/- 10%, 6.95A, 75W
Power redundancy support	Yes, optional second power supply	Yes, optional second power supply
Power consumption	6.1W, 20.814 BTU (idle) 22.6W, 77.114 BTU (full load)	11.88W, 40.536 BTU/h (idle) 25.33W, 86.429 BTU/h (full load without PoE) 62.48W, 213.190 BTU/h (full load with PoE)
Temperature (operational)	0°C to 40°C (32°F to 104°F)	0°C to 40°C (32°F to 104°F)
Temperature (storage)	-20°C to 70°C (-4°F to 158°F)	-20°C to 70°C (-4°F to 158°F)
Humidity	10% to 90%, non-condensing	10% to 90%, non-condensing
Safety Regulations		
Certifications (safety, EMC, radio)	CE/FCC/IC/RCM/VCCI/CB/UL/CCC/KC/ANATEL	CE/FCC/IC/RCM/VCCI/CB/UL/CCC/KC/ANATEL

See sophos.com/compare-xgs for further technical details.

Sophos Switch

Access layer switches

The Sophos Switch Series offers a range of network access layer switches to connect and power the devices connecting to your local area network (LAN) while adding security controls and segmentation at the all-important LAN edge. Our switches can be managed from Sophos Central alongside all of your Sophos solutions. A local user interface is also available.

Technical specifications

1G Models	
8-Port: CS101-8, CS101-8FP	8 x 1G, 2 x SFP. FP = Full PoE (110W)
24-Port: CS110-24, CS110-24FP	24 x 1G, 4 x SFP+. FP = Full PoE (410W)
48-Port: CS110-48, CS110-48P, CS110-48FP	48 x 1G, 4 x SFP+. P = Partial PoE (410W). FP = Full PoE (740W)
2.5G Models	
8-Port: CS210-8FP	8 x 2.5G, 4 x SFP+. FP = Full PoE (240W). This model supports 802.3bt.
24-Port: CS210-24FP	16 x 1G, 8 x 2.5G, 4 x SFP+. FP = Full PoE (410W).
48-Port: CS210-48FP	32 x 1G, 16 x 2.5G, 4 x SFP+. FP = Full PoE (740W)

Deployment Options

While most 24- and 48-port models will find their future home in a rack, our entry-level 8-port models are also suitable for wall mounting or desktop use, making them the ideal choice for deployments outside of a standard data center environment. All of our switches come with a mounting kit.

Local management of Sophos Switch

Each Sophos Switch includes a local management option that does not require an additional subscription.

See sophos.com/switch for further details.

Sophos Central management of Sophos Switch

A support subscription is required for Sophos Central management which also unlocks additional benefits and features (e.g., advanced RMA, Active Threat Response).

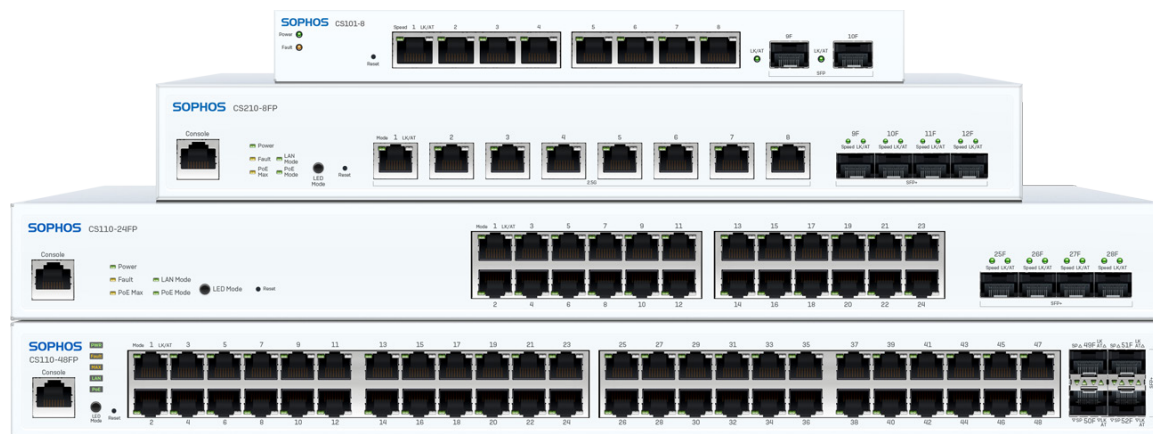

Further Resources

We have a broad range of resources available where you can find out more about Sophos Firewall and related products.

- Sophos Firewall Web – sophos.com/firewall
- XGS Series hardware models – sophos.com/compare-xgs
- Sophos Firewall Ecosystem: Add-ons and accessories – sophos.com/firewall-ecosystem
- Sophos Switch - sophos.com/switch
- Sophos Wireless – sophos.com/wireless
- Sophos Zero Trust Network Access - sophos.com/ztna
- Sophos Managed Detection and Response - sophos.com/mdr

Try It for Free – for Business and Home Use

If you have any questions, visit sophos.com or give us a call.

Free 30-day trial - no strings attached

If you'd like to take it for a test drive, you can get the full-featured product. Simply sign up for our free 30-day trial.

See it in action now

You can take a walkthrough of the user interface with our interactive demo or watch videos showing you just how we make network security simple. Visit sophos.com/firewall for more information.

Free home use version

Our Sophos Firewall Home Edition is a fully equipped software version that gives you complete network, web, mail, and web application security with VPN functionality for home-use only and limited to four virtual cores and 6 GB of RAM. Visit sophos.com/freetools for more information.

United Kingdom and Worldwide Sales
Tel: +44 (0)8447 671131
Email: sales@sophos.com

North American Sales
Toll Free: 1-866-866-2802
Email: nasales@sophos.com

Australia and New Zealand Sales
Tel: +61 2 9409 9100
Email: sales@sophos.com.au

Asia Sales
Tel: +65 62244168
Email: salesasia@sophos.com